

RADIO

ESTABLISHED 1917



DESIGN, RESEARCH
PRODUCTION, OPERATION

★
DECEMBER, 1942

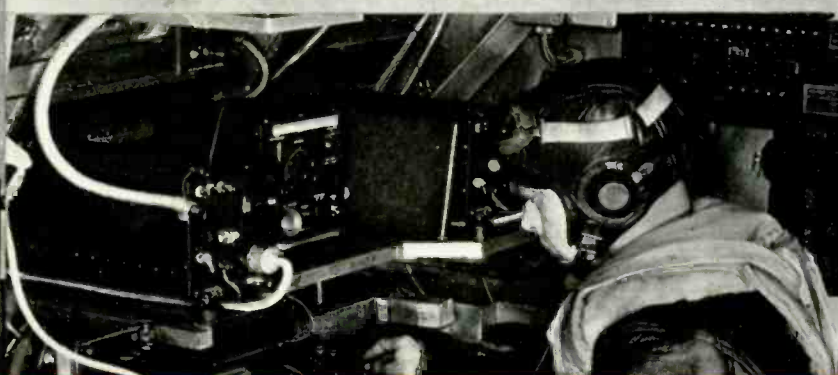
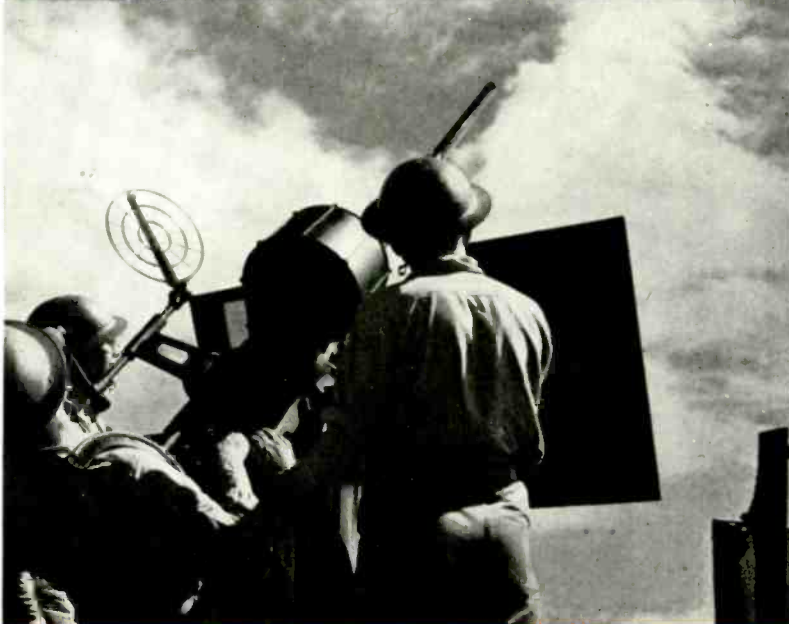
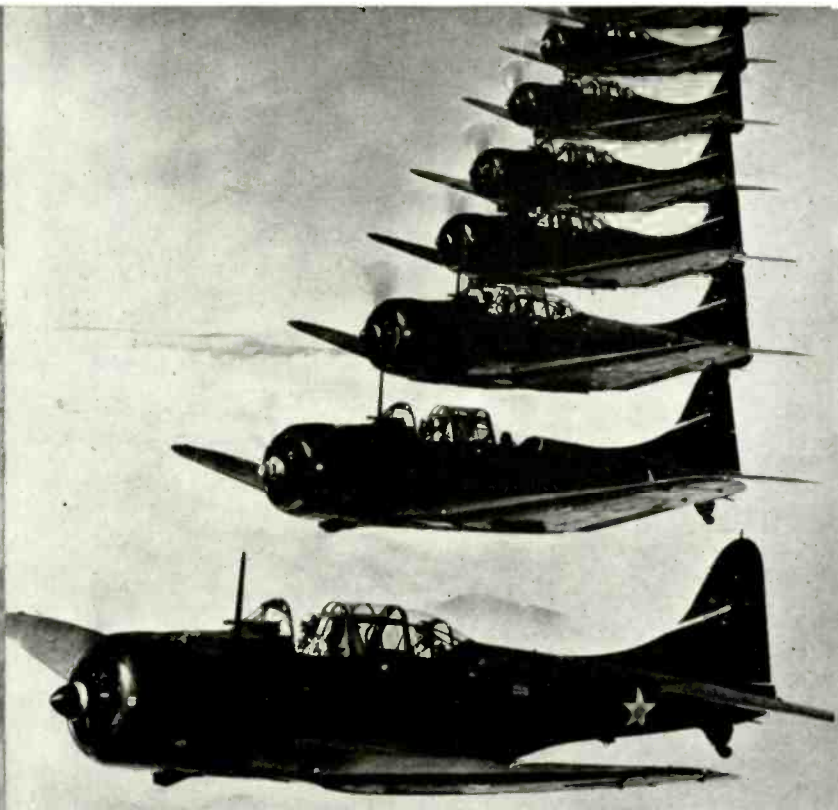

U. S. NAVY OFFICIAL PHOTOS

UTC CASE HISTORIES

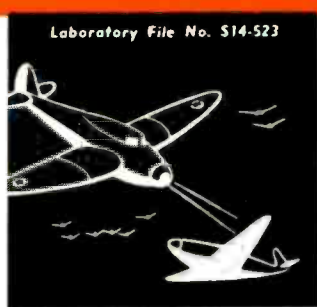

This unit helps "keep them flying." A UTC redesign combined two units in one . . . reduced quantity of critical materials 50% . . . reduced weight and size 40% . . . reduced installation time 60% . . . reduced possible trouble points 50%.

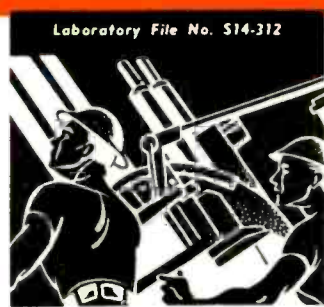

This unit maintains ground communications at a more efficient level. Now plastic housed. Critical materials reduced 50%. UTC design reduced possible trouble points 50% . . . reduced difficulty of operation 50%.

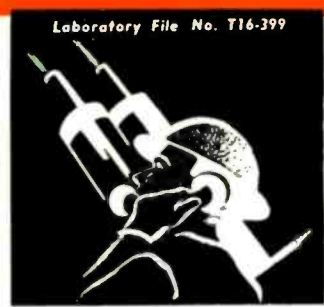

This unit is used at a number of points in aircraft communication. A UTC design reduced quantity of critical materials used 20% . . . reduced weight and size 20% . . . reduced possible trouble points 50%.

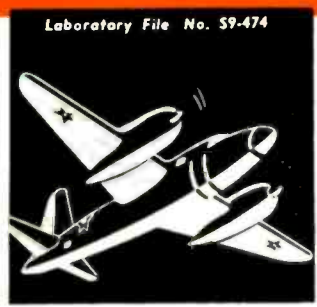

This unit is a component in a piece of aircraft equipment. A UTC design reduced quantity of critical materials 60% . . . reduced weight and size 60% . . . made possible a similar reduction of size and weight in the complete equipment of which it is a component.

WHAT CAN WE DO FOR YOU?

UNITED TRANSFORMER CO.

150 VARICK STREET



NEW YORK, N. Y.

EXPORT DIVISION: 100 VARICK STREET NEW YORK, N. Y. CABLES: "ARLAB"



Christmas 1942

We have come a long way since last Christmas, all of us. American Amateurs have flocked to the colors — made themselves the backbone of the great Army Signal Corps and Navy Communications. Makers of Amateur equipment have put their entire effort into design and construction of Military communications units. For example, the Hallicrafters have, since Pearl Harbor, turned out production that would normally have taken seven years! ☆ We can all be proud that we have in one short year turned the tide of battle from almost unopposed conquest by the enemy to the first stages of the Victory drive on every front. And, let us all fervently hope that another wartime Christmas will be unnecessary.

W. J. Halligan

the hallicrafters co.
CHICAGO, U. S. A.





Panoramic **RECEPTION!** **THE VISIBLE SPECTRUM OF RADIO FREQUENCIES**

Research and development engineering in the Hallicrafters laboratories goes constantly forward . . . keeping ahead of the fast moving pace of today's defense requirements for communications equipment.

Panoramic reception is only one of the many new developments Hallicrafters will be the first to introduce when short wave equipment is again available for civilian use.

the hallicrafters co.
 CHICAGO, U. S. A.
Keep Communications Open!

RADIO

Published by RADIO MAGAZINES, INC.

Editor

M. L. MUHLEMAN

Business Staff

Lee Robinson, Publisher
and President

S. R. Cowan, Business Manager
and Treasurer

M. L. Muhleman, Vice President
and Editor

R. Alan, Circulation Manager

CORRESPONDENCE and ORDERS should be sent only to our New York office. MANUSCRIPTS, if unsolicited and unusable, will not be returned unless accompanied by a stamped, self-addressed envelope.

EXECUTIVE, editorial, and advertising offices of Radio Magazines, Inc., are located at 132 West 43rd Street, New York, N. Y., to which address all correspondence, advertising copy and cuts should be directed.

SUBSCRIPTION RATES (in U. S. funds): Two years, \$5.00, or \$3.00 yearly in U.S.A. To Canada and all foreign countries, \$4.00 yearly. Twelve issues yearly; back issues are not included in subscriptions.

NOTE: Because of wartime censorship restrictions, we must reserve the right to withhold from foreign subscribers any issue the regular domestic edition of which is not approved by the authorities for export without changes. In such cases subscriptions will be extended so that each subscriber will eventually receive the number of issues to which he is entitled.

IF YOU MOVE, notify us in advance; we cannot replace copies sent to your old address. Notice must be received by the 20th of the month preceding the cover date of first issue to go to the new address.

DECEMBER 1942

No. 275

Table of Contents

COVER

Under the watchful eye of Cecilia A. Ray this heavy drill press toes the mark in the line-up of machines and women producing for victory at Western Electric's Point Breeze plant. Where, in the last war, women entered the business field, this war sees them entering industry—and probably to stay.
Photo by Holmes I. Mettee, Baltimore, Md.

ARTICLES

Notes on Bridge Balancing— <i>C. F. Nordica</i>	9
U.H.F. Magnetron Oscillators— <i>Edward M. Noll</i>	12
Application of Vector Algebra— <i>Cortlandt Van Rensselaer</i>	14
Radio Design Worksheet: No. 8—Power and Gain	17
Q. & A. Study Guide— <i>C. Radius</i>	19
New Tube Types 2AP1, 6AG5, 6J6, 5R4-GY	20
"Audio" Weighing Scale	21
Radio Bibliography: 7—Remote Control, Part 2— <i>F. X. Rettenmeyer</i>	26

MISCELLANEOUS

Editorial	7
New Products	22
This Month (News)	24
New Catalogs	45
Advertising Index	50

RADIO (title registered U.S. Pat. Off.) is published monthly at 34 N. Crystal Street, East Stroudsburg, Pa., by Radio Magazines, Inc., Executive and Editorial Offices at 132 West 43d Street, New York, N. Y. Subscription rates—United States and Possessions, \$3.00 for 1 year, \$5.00 for 2 years; elsewhere \$4.00 per year. Single copies 35c. Printed in U.S.A. All rights reserved, entire contents Copyright 1942 by Radio Magazines, Inc. Entered as Second Class Matter October 31, 1942, at the Post Office at East Stroudsburg, Pa., under the Act of March 3, 1879.

RADIO

★ DECEMBER, 1942

5

Jensen

**SPEECH REPRODUCERS
HAVE GONE TO SEA!**



... and they are real seagoing reproducers! ... because each one has been specially constructed and meticulously engineered for perfect performance under the most severe operating conditions.

Jensen
RADIO MANUFACTURING CO.
6601 SO. LARAMIE AVENUE, CHICAGO

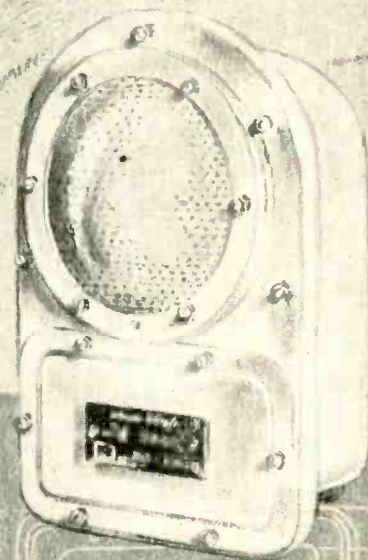

EDITORIAL

ACCIDENT—THE SABOTEUR

★ Led by business and industry, America is organizing the greatest counter-attack on accidents in all history. Faced by mounting casualties on the home front already exceeding those on the fighting front, the country is at last taking unified action to curb the sabotage of manpower by accident.

Since Pearl Harbor 85,000 persons in all have been killed by accident in the United States, 7,700,000 injured. Destruction of human material on this grand scale means something more than personal tragedy endlessly repeated. It means that 410,000,000 man-days of work have been lost. These man-days might better have been spent turning out tanks, planes, guns, ships and the thousand and one complementary materials of war.

Of these fatalities 42,000 were workers—at a time when manpower is the Nation's major non-military concern. Only one out of eight industrial establishments—there are 196,000 in all—is fully covered by a safety program. Even more alarming, three out of five workers injured were struck down not in line of duty at furnace, press or lathe, but off the job.

Whatever the background of our accident-experience, its end effects are a gross waste of skills, serious lapses of efficiency while replacements are trained, and steady impairment of morale. When the trend has reached a pitch where ten firms are required to keep careless Americans supplied with glass eyes and twenty-five more with crutches, the time is ripe to call a halt.

A halt has been called. The first move was made by the President of the United States, in a proclamation calling on the National Safety Council "to mobilize its nation-wide resources in leading a concerted and intensified campaign against accidents."

The National Safety Council had thirty years of invaluable experience to draw on. It has plenty of ideas for concrete action. It knew exactly what it would need in the way of increased staff and public cooperation. But to move into wartime high gear with a program big enough to meet the national accident crisis, money for an adequate emergency budget was needed.

At this point business and industry stepped to the fore. In a spirit of wartime public service, representative leaders decided to undertake the financing of the Council's biggest assignment, and organized the War Production Fund to Conserve Manpower.

A national committee of more than 600 members was formed, with an executive committee of 74—both made up of senior executives in nationally prominent firms. A preliminary canvass through the national connections of major companies has yielded above one million dollars in cash and nearly another in oral commitments. At present regional campaigns are getting

under way in major industrial centers from coast to coast.

Many big firms have contributed heavily to the War Production Fund despite the fact they already have excellent safety programs in effect. They are aware that some outside agency with specialized experience is needed to coordinate safety off the job, where three out of five accidents affecting workers happen. They will also welcome technical assistance in handling the brand new problems of safety for the army of women in industry, and of safety in the homes temporarily neglected for drill press and assembly bench. The same goes for accident-prevention methods to protect 'teen age boys and older men now filling the shoes of men drawn into the armed forces.

The National Safety Council has worked out a very careful plan for putting an anticipated \$5,000,000 to work. No radical departures from previous practice are contemplated. The general strategy will be to speed up the existing program, to get more coverage, more technical assistance in the field, and above all, more public cooperation in accident-prevention.

194X

★ When this year arrives, a great many things will have happened, and by the nature of these things the large and the small factors that govern our lives will assume perspective.

In 194X the war will have ended, and the nature and substance of our victory will rest upon the results at the peace table and the temper of our people. Because no one knows what the end of the war will bring, X, the unknown, looms large in our minds.

In the category of the smaller things the temper of the people of this country, if not the world, will exert itself upon the way things are to be done—and we venture the guess that this way is not the way some industrialists have planned things for the post-war period. The people expect a housecleaning, and what the people want they will get, or it will be just too bad.

And speaking of smaller things: If it were not for the fact that the demand for radio equipment for commercial use will be simply staggering after the war is over, we doubt if many parts and component manufacturers would continue to serve the radio field. There is no profit in serving manufacturers of civilian radio equipment who permit the matter of price to so govern their activities that the quality of parts and components is, by necessity, forced down to such a low point that new receivers break down in a matter of weeks or months.

The inexpensive receiver has been a boon to the lower class, and to the radio industry, but not when it has been designed below reasonable engineering standards in order to meet a preconceived price structure.—M.L.M.

The high regard in which IRC Resistors are held by Engineers and Executives of America's leading electronic industries is clearly attested by the voluntary remarks quoted at the right. These are taken from among returns to a nation-wide marketing study recently made by a wholly independent research organization. This survey was completely unbiased, with no company name or product disclosed.

PREFERRED
for
PERFORMANCE



FIXED AND VARIABLE

RESISTORS

**INTERNATIONAL
RESISTANCE COMPANY**

411 NORTH BROAD STREET
PHILADELPHIA, PA.

WE QUOTE

"We require quality, uniformity, service—and IRC have proven without a doubt definitely reliable."

"IRC seems to be choice of engineers in the government radio research job I'm in."

"Most complete engineering data."

"Most stable as determined by laboratory tests over two-year period."

"... In my business, Aircraft Electrical Engineering, I always specify IRC."

"Fine people to do business with."

"We handle only one line of resistors and of course that must be the best—namely IRC."

"To us, in the Company, the IRC mark on a resistance is the equivalent to a hallmark on sterling."



IRC files the flag of the Army-Navy Production Award for "high achievement."

NOTES ON BRIDGE BALANCING

C. F. NORDICA

★ It is common practice in Wheatstone bridge circuits to balance out stray impedance—particularly stray capacities—in the two fixed arms. It is the purpose of this article to present some of the better-known bridge circuits, and deal with the factors involved, and the derived expressions, related to degree of error.

Balancing Procedure

In Fig. 1, let A and B be the fixed arms of the bridge. Let S be the standard impedance and X the unknown impedance, the value of which is to be determined.

Assume S and X arms are disconnected from circuit at c and d , and let a balance be made with s' and x' to balance out strays. Then at the null point we have:

$$\frac{A}{B} = \frac{s'}{x'} \quad (1)$$

Connecting the arms S and X at c and d and rebalancing without disturbing the arms s' and x' yields, at balance:

$$\frac{A}{B} = \frac{s'S_1}{s' + S_1} \times \frac{x'X}{x'X} \quad (2)$$

Connect the detector terminal of S to d and the detector terminal of X to c and rebalance to obtain:

$$\frac{A}{B} = \frac{s'X}{s' + X} \times \frac{x' + S_2}{x'S_2} \quad (3)$$

Eliminating s' and x' from (1), (2) and (3) yields

$$X = \sqrt{S_1 S_2} \quad (4)$$

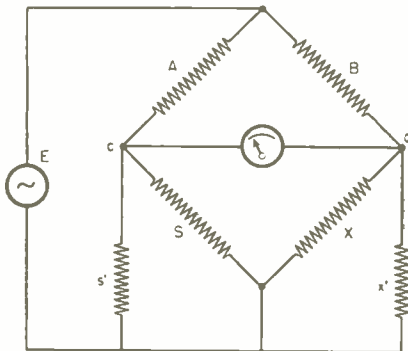

Fig. 1. Circuit illustrating balance procedure.

The significance of (4) is that by making three balances, the value of the unknown impedance X may be expressed independently of A and B .

Let A/B be nearly unity so that:

$$S_2 = S_1(1 + a)$$

Then, from (4), we have:

$$X = \sqrt{S_1^2(1+a)} = S_1(1+a/2) \quad (5)$$

if a is small compared to 1. Since the balance of equation (1) with arms S and X disconnected at c and d is seldom pronounced due to the relatively small amount of energy delivered to the network (x' and s' are usually large with respect to S and X in actual practice), an error in the balance may occur. To investigate this error let $A/B = 1$.

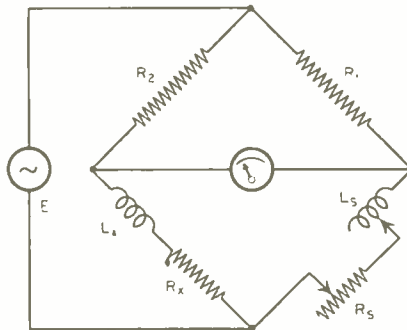

Fig. 2. Inductance comparison bridge circuit.

Solving (2) and (3) for s' and equating we have:

$$X = \frac{2S_1 S_2}{S_1 + S_2} \quad (6)$$

which is independent of the original balance. If we again let $S_2 = S_1(1 + a)$,

$$X = S_1(1 + a/2), \quad (7)$$

if a is small compared to 1

From the above it is obvious that the process of reversing arms S and X and taking the geometric mean value of the two readings as the value of the unknown impedance, nullifies slight errors in both ratio arms and original balance.

The conditions of balance of some of the more common types of bridge

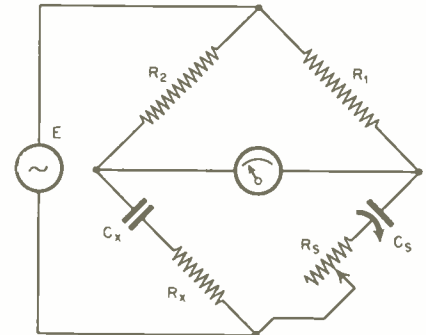

Fig. 3. Capacity comparison bridge circuit.

are given in the following paragraphs.

Inductance and Capacity Bridges

INDUCTANCE COMPARISON BRIDGE: The unknown is assumed to be an impedance having both inductance and resistance, such as a coil. The circuit is shown in Fig. 2. The condition for balance is:

$$\frac{R_1}{R_2} = \frac{R_s}{R_x} = \frac{L_s}{L_x}$$

or:

$$R_s = R_x \frac{R_2}{R_1}$$

and:

$$L_s = L_x \frac{R_2}{R_1}$$

R_s will, in this case, include the resistance of the standard inductance used, as well as that of the variable standard resistance to balance R_x . Commonly $R_1 = R_2$ whence:

$$\frac{R_s}{L_s} = \frac{R_x}{L_x}$$

CAPACITY COMPARISON BRIDGE: This bridge is essentially similar to the inductance comparison bridge of Fig. 2. Its circuit is shown in Fig. 3. For balance we have:

$$C_s = C_x \frac{R_1}{R_2}$$

and:

$$R_s = R_x \frac{R_2}{R_1}$$

For equal ratio arms:

$$C_s = C_x \text{ and } R_s = R_x.$$

The bridge of Fig 3 yields the effec-

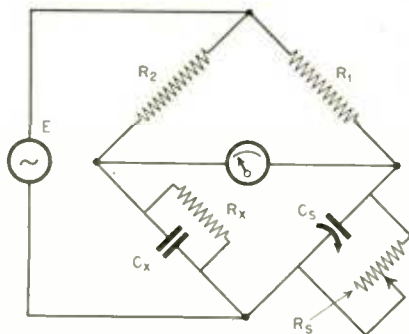

Fig. 4. Circuit for finding shunt capacity.

tive series resistance and capacitance of the unknown impedance. To find the effective shunt capacity and shunt resistance, the standard resistance and capacitance are arranged in shunt, as shown in Fig. 4. In this case, for balance we have:

$$C_s = C_x \frac{R_1}{R_2}$$

$$R_s = R_x = \frac{R_2}{R_1}$$

and for equal ratio arms:

$$C_s = C_x$$

$$R_s = R_x$$

RESONANCE BRIDGES: The bridge circuits of Figs. 2, 3, and 4 compare unknown inductances with standard inductances, or unknown capacities with standard capacities. There are bridges which compare unknown inductances (sometimes mutual inductance) with standard capacities, or vice versa. In such bridges, frequency is a fundamental variable and must be known accurately. This type of bridge is generally known as a resonance bridge. The circuits rely on opposing phase angles in the unknown and standard arms to effect balance. A simple type is shown in Fig. 5.

In this case we have:

$$\frac{R_1}{R_2} = \frac{R_s + j(\omega L_s - 1/\omega C_s)}{R_4}$$

At balance:

$$\omega L_s - 1/\omega C_s = 0$$

or:

$$L_s = 1/\omega^2 C_s$$

and:

$$R_s = R_x \frac{R_1}{R_2}$$

It is noteworthy that the reactance balance is independent of the fixed ratio arms R_1 and R_2 while the resistance balance is not. The balance is effected at a single frequency and any harmonics of E (or other extraneous frequencies) may appear in the detector mesh.

Another less simple type of resonance bridge is shown in Fig. 6. It is sometimes called the Owen Bridge.

At balance:

$$\frac{R_1 + R_s + j\omega L_s}{R_3} = \frac{R_2 - j1/\omega C_2}{-j1/\omega C_4} = \frac{1/C_2 + j\omega R_2}{1/C_4}$$

Equating real and imaginary components:

$$\frac{R_1 + R_s}{R_3} = \frac{C_4}{C_2}$$

and:

$$R_s = R_3 \frac{C_4}{C_2} - R_1$$

$$j \frac{\omega L_s}{R_3} = j\omega R_2$$

or:

$$L_s = R_2 R_3 C_4$$

The quantities R_3 , C_2 and C_4 may be fixed, and R_1 used as a variable to determine R_x . The two adjustments are independent.

Mutual Inductance Bridges

HUGHES MUTUAL INDUCTANCE BRIDGE: Fig. 7-A shows one form of the Hughes mutual inductance bridge, which is in turn one of several types. In some

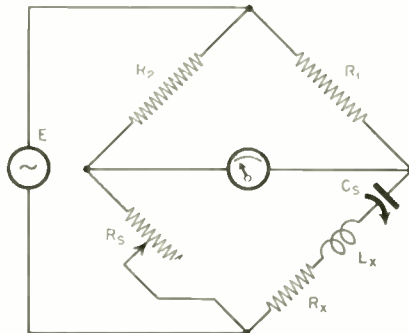

Fig. 5. Circuit of resonance type bridge.

types, mutual inductance is balanced against self inductance, in others against capacitance, and in still other types against another mutual inductance.

The bridge shown in Fig. 7-A is obviously of the first type. In this bridge three arms are resistances (R_1 , R_3 and R_4). Coupling or mutual inductance exists between the generator and detector meshes. Under conditions of bal-

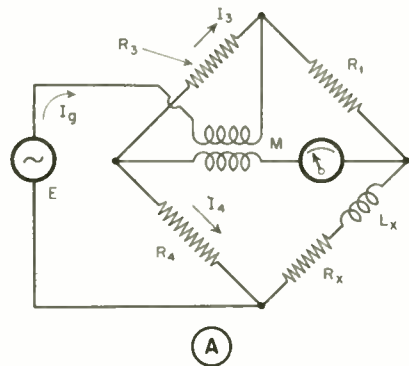

Fig. 7. (A), Hughes mutual-inductance bridge. (B), its equivalent circuit.

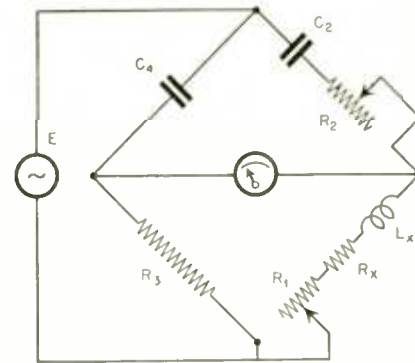

Fig. 6. Circuit of the Owen bridge.

ance, the detector current must be zero, so no energy can be transferred by mutual inductance M from the detector mesh to the generator mesh. The voltage introduced via this route from the generator mesh into the detector mesh is obviously:

$$e = -jI_g \omega M = jI_s \omega M - jI_s \omega M$$

This is equivalent at balance to a bridge circuit in which the mutual inductance exists between arms 3 and 4 and the generator mesh. This in turn can be shown to be equivalent to a mutual impedance in every arm. Such an equivalent circuit is shown in Fig. 7-B. For this arrangement we may write:

$$\frac{R_1 + j\omega M}{R_3 + j\omega M} = \frac{R_s - j\omega(L_x + M)}{R_4 + j\omega M}$$

but from the previous equation:

$$R_1 R_4 + j\omega M(R_1 + R_4) - \omega^2 M^2 = \frac{R_s R_3 - j\omega(L_s R_3 - M R_3 + M R_4) - \omega^2 M L_s - \omega^2 M^2}{\omega^2 M L_s - \omega^2 M^2}$$

or:

$$R_1 R_4 - R_s R_3 + \omega^2 L_s M + j\omega M(R_1 + R_4 + R_3 - R_4) + j\omega L_s R_3 = 0$$

Equating real and imaginary terms, we have:

$$R_1 R_4 - R_s R_3 - \omega^2 L_s M = 0$$

$$M(R_1 + R_3 + R_4 + R_1) = L_s R_3$$

Whence we find:

$$L_s = M \frac{R_1 R_4}{R_3} \left[\frac{1}{R_3} + \frac{R_1 + R_3 + R_4}{R_1 R_4} \right] \left[1 + \frac{\omega^2 M^2}{R_3^2} \right]$$

$$R_x = \frac{R_1 R_4}{R_2} \left[\frac{1 - \frac{\omega^2 M^2 (R_1 + R_3 + R_4)}{R_1 R_3 R_4}}{1 + \frac{\omega^2 M^2}{R_3^2}} \right]$$

HEAVISIDE MUTUAL INDUCTANCE BRIDGE:
Fig. 8-A shows the schematic of the Heaviside mutual inductance bridge, probably the most important of its type. The equivalent circuit is shown in Fig. 8-B.

In this arrangement mutual inductance exists between the generator mesh and one bridge arm. At balance:

$$\frac{R_1}{R_2} = \frac{R_x + j\omega(L_s - M)}{R_4 + j\omega(L_4 + M)}$$

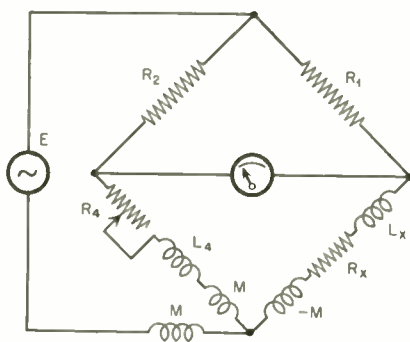
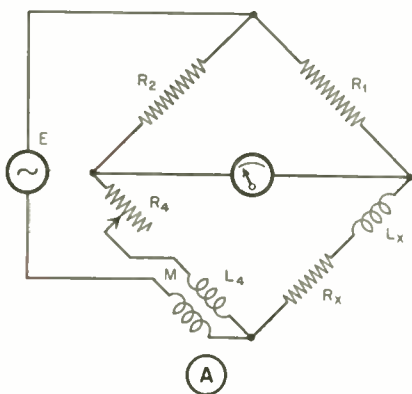

Fig. 8. (A), Heaviside mutual inductance bridge, and equivalent.

Whence:

$$R_x = \frac{R_1 R_4}{R_2}$$

and:

$$\frac{R_1}{R_2} = \frac{L_s - M}{L_4 + M}$$

or:

$$L_s = \frac{R_1}{R_2} L_4 + M \left(\frac{R_1}{R_2} + 1 \right)$$

When fixed ratio arms R_1 and R_2 are equal,

$$\begin{aligned} R_x &= R_4 \\ L_s &= L_4 + 2M \end{aligned}$$

CAREY FOSTER MUTUAL INDUCTANCE BRIDGE:

In this network, an unknown mutual inductance may be measured in terms

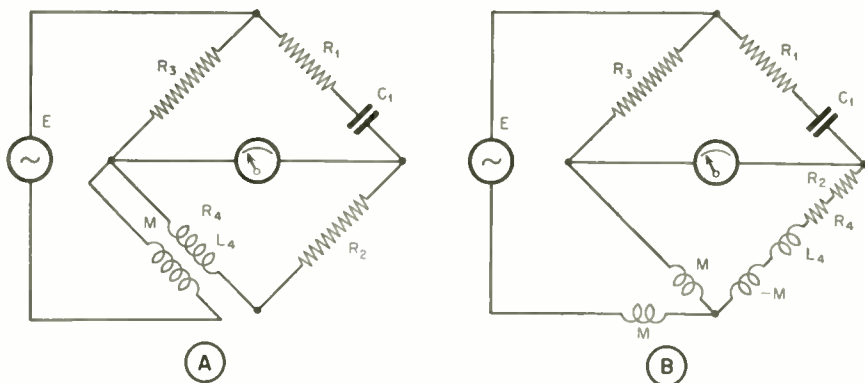

Fig. 9. Carey Foster mutual-inductance bridge and its equivalent circuit.

of a standard capacity. The schematic is shown in Fig. 9-A and its equivalent circuit in Fig. 9-B. The condition for balance is

$$\frac{R_1 - j1/\omega C_1}{R_2} = \frac{R_3 + R_4 + j\omega(L_3 - M)}{j\omega M}$$

Whence:

$$R_2(R_3 + R_4) - M/C_1 = j\omega[M(R_1 + R_3) - R_1 L_4]$$

Equating each side to zero and solving for M yields:

$$M = C_1 R_2 (R_3 + R_4)$$

Also:

$$M = L_4 \frac{R_2}{R_1 + R_3}$$

Hence R_3 and either R_2 or C_1 may be simultaneously varied to obtain balance, since these variables appear independently in the above equations.

Ratio Bridge

TRANSFORMATION RATIO BRIDGE: The mutual inductance type of bridge may be used to measure the voltage (or impedance) ratio of a two-winding transformer, such as that shown in Fig. 10-A. The equivalent circuit of the transformer is shown in Fig. 10-B.

When the windings are connected series-aiding, the ratio of the two equivalent series arms ($Z_1 + Z_M$) and ($Z_2 + Z_M$) correspond to the voltage transformation ratio. Assume unity coupling between primary and secondary; then:

$$\begin{aligned} Z_M &= \sqrt{Z_1 Z_2} \\ \text{and:} \\ \frac{Z_2 + Z_M}{Z_1 + Z_M} &= \frac{Z_2 + \sqrt{Z_1 Z_2}}{Z_1 + \sqrt{Z_1 Z_2}} = \frac{\sqrt{Z_2}(\sqrt{Z_1} + \sqrt{Z_2})}{\sqrt{Z_1}(\sqrt{Z_1} + \sqrt{Z_2})} = \sqrt{\frac{Z_2}{Z_1}} \end{aligned}$$

Let the transformer of Fig. 10-A be connected into the bridge circuit of

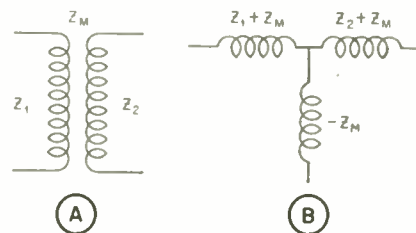

Fig. 10. Two-winding transformer and its equivalent.

Fig. 11-A, the equivalent circuit of which is shown in Fig. 11-B. Then, when R_4 is adjusted for balance, we have:

$$\frac{R_4}{R_2} = \frac{Z_2 + Z_M}{Z_1 + Z_M} = \sqrt{\frac{Z_2}{Z_1}} = \text{voltage ratio.}$$

It is interesting to note that if one winding of the transformer is reversed, so that Z_M is negative (opposing) the bridge cannot be balanced. For this condition we have:

[Continued on page 46]

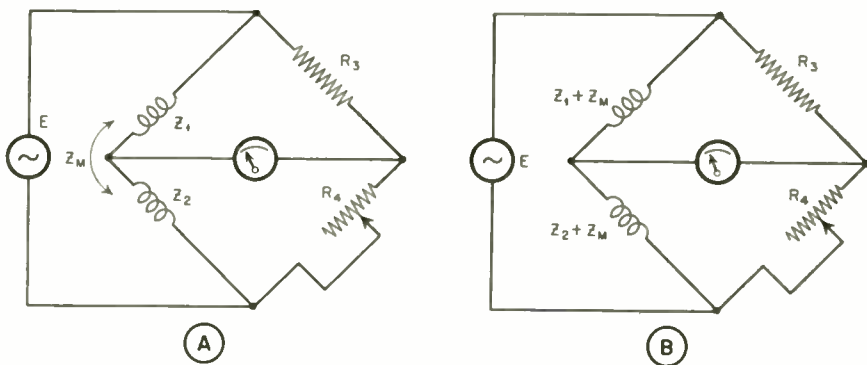

Fig. 11. Circuit, and its equivalent, of transformation-ratio bridge.

U. H. F. MAGNETRON OSCILLATORS

EDWARD M. NOLL

★ The post-war era in radio will have a decided trend toward higher and higher frequencies. What is being developed now and what will be developed after the conflict, in the fields of television, FM, aircraft radio, and ultra-high frequency technique will change the pattern of things considerably.

The magnetron oscillator, or some development of its basic characteristics, will find wide application as an efficient ultra-high-frequency generator. This article will cover the basic theory of the magnetron and some of its pre-war variations.

Electron Transit Time

Before proceeding to the magnetron, let us first consider the actions of electrons at ultra-high frequencies. Two of the limiting factors of using the ordinary high-vacuum tube at u.h.f. is the interelectrode capacities and the electron transit time. In the case of interelectrode capacities, the reactance drops to an active value at ultra-high frequencies. The low reactance will cause high circulating currents and a consequent drop in efficiency.

In the movement of electrons from cathode to plate a finite time is involved. At low frequencies the time required for electron transit is very minute compared to the time of one

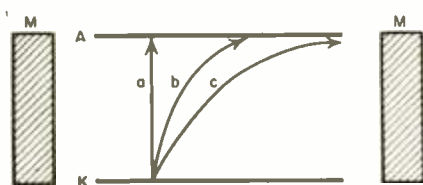

Fig. 1. Motion of electrons between two parallel plates (K — cathode, A — anode), where (a) is motion of electrons under no magnetic field, and (b) their motion under influence of magnetic field from pole pieces M, with the field not sufficiently strong to prevent electrons from reaching plate A. Line (c) shows motion with critical magnetic field applied which is just strong enough to prevent electrons from reaching anode.

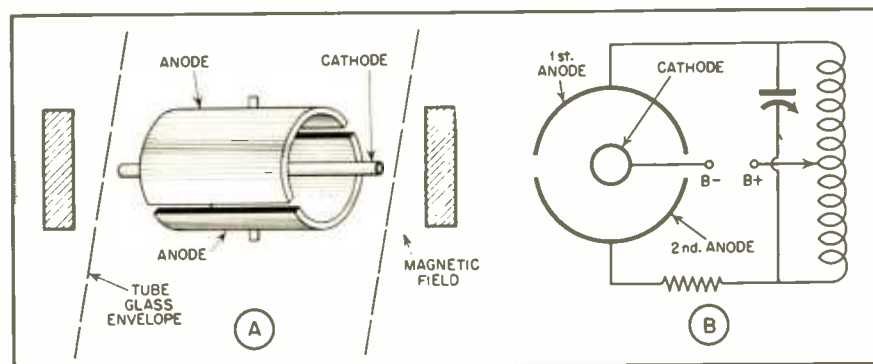

Fig. 3. Construction of split-anode magnetron, and its circuit.

cycle; however, it amounts to a comparable amount at u.h.f. As these electrons pass tube electrodes they produce a varying potential on the electrodes. This variation occurs over a considerable portion of the u.h.f. cycle and induces current in the external circuit, thus requiring additional excitation to maintain proper electrode potentials.

In the operation of an oscillator or radio-frequency amplifier, only those electrons passing from cathode to plate during one-half of the cycle can contribute to the alternating component of plate current. Because of the electron lag at ultra-high frequencies, after the grid cycle reverses, there are electrons held between cathode and grid and between grid and plate. The electrons caught between cathode and grid return to the cathode due to the increasingly negative grid potential, resulting in high kinetic loss; while those electrons between grid and plate are drawn with increasing velocities toward the increasingly more positive plate, resulting in further high kinetic losses. These losses were first explained by Lindenblad¹. In the case of an oscillator at ultra-high frequencies, the phase lag caused by the finite electron transit time may be great enough to prevent the attainment of proper grid and plate potentials necessary for regeneration.

One of the solutions to the transit-time problem is the development of small tubes with close-spaced electrodes

which reduce the time required for electron transit and also prevent an excessive amount of electrons gathering between electrodes. However, these tubes are very limited as far as power output is concerned and also present a lower reactance due to the close electrode spacing and consequent greater interelectrode capacities. The solution to efficient operation at "jeep" frequencies is the development of tubes especially designed to utilize the oscillations of the electrons within the tube itself, instead of producing oscillations by means of an external circuit.

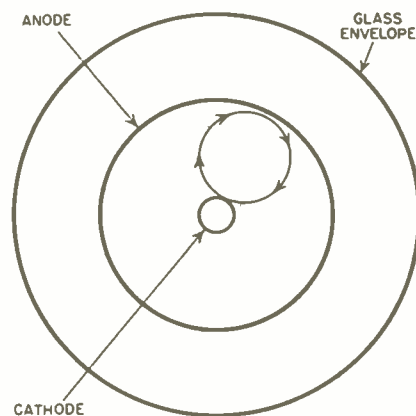

Fig. 2. Basic magnetron showing motion of electron under the influence of critical value of magnetic field applied parallel with the cathode by an external source.

The Basic Magnetron

The basic magnetron consists of a cathode and a cylindrical anode plus an external source of magnetic flux. In *Fig. 1* is shown the manner in which a magnetic field will influence the passage of current between two parallel plates. At the critical value of magnetic field all the electrons will just miss the anode and eventually return to the cathode. This is shown in the sketch of the basic magnetron, *Fig. 2*.

There will be an electron cloud formed near the anode where the magnetic field and electrostatic field around the anode will oppose each other and slow the electrons down. There will also be a similar electron cloud near the cathode, as the motion of electrons emitted by the cathode will be opposed by the returning electrons under the influence of the magnetic field. Now we find by attaching an external circuit between cathode and anode, these oscillations will be induced into the external circuit.

This type of magnetron, utilizing electronic oscillation, is capable of generating ultra high frequencies but its efficiency is very low and it is not capable of sufficient power output.

The Split-Anode Magnetron

The split-anode magnetron, *Fig. 3*, and its variations are the most widely used types. This magnetron operates at higher efficiency and is capable of much greater output.

The split-anode magnetron consists of a cylindrical anode composed of two sections, and a coaxial filament; the strength of the magnetic field is approximately $1\frac{1}{2}$ times the critical value, this being the value at which all electrons would be prevented from reaching the anodes provided both plates are operated at the same potential.

In practical operation, the anodes are operated at different potentials, and by so doing, the electrons produce negative resistance oscillations. We find, as demonstrated and explained by Kilgore⁴, that there is a particular ratio of anode potentials which will cause the electrons to fall onto the low-potential plate. The frequency of oscillations will depend on the constants of the external lines attached to the anodes of the split-anode magnetron.

In *Fig. 4*, we see the movement of electrons at the proper anode potential ratio. The electron leaving the cathode and progressing toward the high-potential plate will be deflected by the magnetic field at a certain radius of curvature. After passing the division of the two anodes, the electron enters the electrostatic field set up by the low-

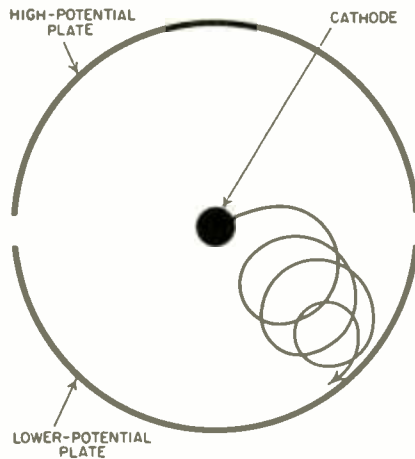

Fig. 4. Illustrating the movement of an electron in combination with a magnetic field, and under the influence of a high- and a low-potential plate.

er potential anode; therefore, the magnetic field will have more effect on the electrons and they will be deflected at a smaller radius of curvature. The electron will continue to make a series of loops through the electromagnetic and electrostatic fields until it finally falls onto the low-potential anode. The electron leaving in the direction of the low-potential anode, it is believed, will eventually reach the low-potential anode.

The proper ratio of anode potentials is approximately four to one. If the ratio is decreased there will be more loops and more space change, therefore less current reaching the low-potential plate. If the ratio is increased, the negative resistance effect will be overcome and electrons will begin arriving on the high-potential plate.

Magnetron Refinements

There are a number of refinements which, when added to the basic magnetron, contribute to its more efficient operation and greater power output. Since a high magnetic field is required,

to use a practical magnet the plate is limited in size which also limits the plate dissipation. However, tubes have been constructed using a heavy walled area, thus increasing the radiating area (Kilgore⁴).

Water-cooled magnetrons have also been used. Another type of magnetron, called the "anode-tank circuit magnetron," which has operated at 22% efficiency at 3750 megacycles, has been developed (Linder⁶). In this magnetron, the anodes are made a quarter-wave long and their ends shorted at one end. This composes the resonant circuit at which the magnetron oscillates, as shown in *Fig. 5*. This construction permits a greater heat-radiating surface and reduces the effects of lead inductance and interelectrode capacities.

There have been some four-anode magnetrons which are believed to operate at higher efficiencies. In some magnetrons in addition to the magnetic, an aiding electrostatic field is created by applying potential to two metallic discs, thus aiding the stability of the tube (Wolff-Linder⁵).

Bibliography

1. N. E. Lindenblad, Proc. I.R.E., Sept., 1935: *Development of Transmitters for Frequencies Above 300 Megacycles*.
2. Robert F. Shaw, QST, July, 1942: *100 Centimeters and Down*.
3. Okabe, Proc. I.R.E., Jan., 1939: *Electron Beam Magnetrons and Type B Magnetron Oscillations*.
4. G. R. Kilgore, Proc. I.R.E., August, 1936: *Magnetron Oscillators for the Generation of Frequencies Between 300 and 600 Megacycles*.
5. Irving Wolff and E. G. Linder, Broadcast News, December, 1935: *Transmission of 9 cm. Electro-Magnetic Waves*.
6. E. G. Linder, Proc. I.R.E., November, 1939: *The Anode-Tank-Circuit Magnetron*.
7. E. G. Linder, Proc. I.R.E., April, 1936: *Description and Characteristics of the End-plate Magnetron*.

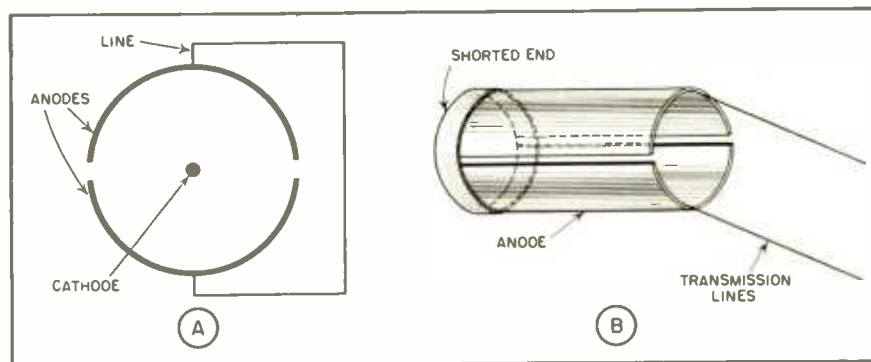

Fig. 5. Split-anode magnetron tank circuits of two different types: (A) where inductance of line and capacity between anodes determines the frequency of oscillation, and (B) where the split anode itself resonates and functions as a tank circuit. (B) also shows the construction of the anode.

APPLICATION OF VECTOR ALGEBRA

CORTLANDT VAN RENSSELAER

★ So many of the problems continually encountered in radio equipment design and operation are so speedily solved through the use of straightforward vector algebra, that a working knowledge of this important phase of mathematics is highly valuable to radio technicians in both military and civilian services.

The Vector

The vector is a graphical representation of current, voltage or impedance in an a.c. circuit. It consists, as shown in Fig. 1, of a *center*, a *body*, and a *tip*. The center is a point about which the body and tip of the vector are considered to be rotating; always in a counterclockwise direction. The body is usually drawn to a scalar length, (1 in. equal to 100 volts, ¼ in. equal to 1 amp. etc.) but in many cases, principally when the vector is used to represent phase relationships between currents, voltages, and impedances in a complex circuit, the scalar length is unimportant, and is drawn arbitrarily.

The relationship between the vector and the sine wave it represents is shown in Fig. 1. One can see that at any instant, the projection of a point on the sine wave to a vertical axis, is equal to the projection of the vector tip on the same axis. It is also clear that the vector moves through one revolution during one complete sine wave cycle.

The vector so defined, when projected, represents instantaneous values

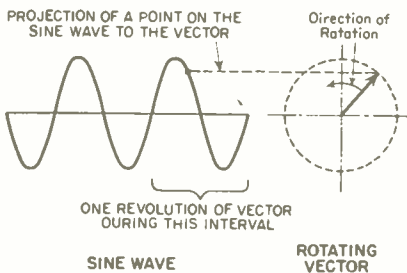

Fig. 1. Relation between sine wave and vector.

of voltage and current since the length of its vertical projection on the reference axis varies in exact accordance with the length of the vertical projection of the instantaneous values on the sine wave. However, in general practice, it is not the peak values of current and voltage we are concerned with, but rather, the *effective* values, or those which will produce a heating effect of the same magnitude as that produced by a direct current and voltage of equivalent value. The relationship between peak and effective quantities can readily be determined. The instantaneous power, p , as shown in Fig. 2, is equal to the product of e and i , the instantaneous peak quantities of current and voltage. The average pow-

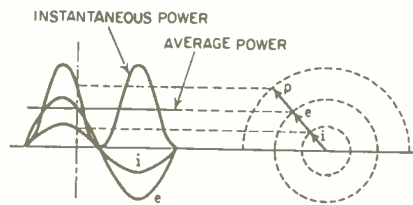

Fig. 2. Power in a resistive circuit.

er, P , which is equivalent to the product of E and I , direct-current values, will be represented by a line dividing the instantaneous power curve in two equal parts, as shown, and will, therefore, be

$$P_{AV} = \frac{ie}{2} = \frac{i}{\sqrt{2}} \times \frac{e}{\sqrt{2}} = 0.707 i \times 0.707 e$$

from which

$$I_{\text{effect.}} = 0.707 i$$

$$E_{\text{effect.}} = 0.707 e$$

The effective value of a.c. quantities is called the r.m.s. or root-mean-square value.

Advantages of Vector Notation

The principal advantage in using vector notation rather than sine formu-

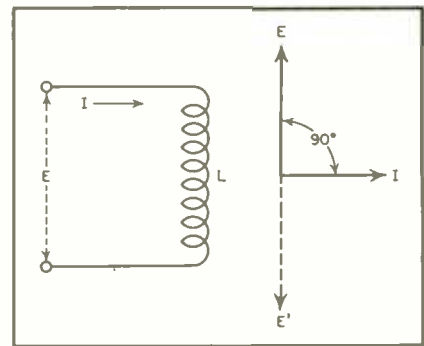

Fig. 3. Voltage applied to a pure inductance.

las in defining an alternating current or voltage quantity is the simplification involved when applying algebraic manipulation to these quantities. For instance, two voltages entering a network may be resolved immediately into one, their resultant, if they are expressed vectorially; whereas, should they be defined in terms of sine formulas, a considerable manipulation must be performed in order to obtain the answer.

Everyone who is familiar with a.c. theory will recall that when a voltage is applied to the terminals of a network containing inductance or capacity, the peak value of current will not flow at the same instant as does the peak value of the applied voltage. This condition is represented in Fig. 3, in which a voltage is applied to a pure inductance. It can be seen that the voltage in this case is maximum when the current is equal to zero. The vector diagram at the right indicates that the maximum voltage is displaced from the maximum current by an angle of $+90^\circ$, assuming the current vector drawn along the zero axis as the reference. This difference between current and voltage is called the *phase angle*, and in this instance the voltage is said to lead the current by 90° since its rotating vector would pass a certain point 90° before the current vector would do so. Had the voltage vector been oriented, as shown by the dotted

lines in Fig. 3, the voltage would have been said to lag the current by 90°.

Assume that in a certain circuit an effective voltage of 10 is leading an effective current by 45°, as shown in Fig. 4. Then we may express the relationship between the current and voltage by two methods: (1) in polar coordinates, for which

$$E = \text{Scalar Length} / \text{Phase Angle}$$

$$E = 10 / +45^\circ$$

or (2) in rectangular coordinates, for which

$$E = \text{Horiz. Distance} \pm \text{Vertical Distance}$$

from origin from origin

$$E = 7.07 + j 7.07$$

The quantity *j*, occurring in the last equation, indicates that the scalar quantity preceded by it is to be measured in a vertical direction.

Converting a Vector

The method for converting a vector equated in one type of coordinates to the other notation is shown by the following example:

Express $E = 100 / +60^\circ$ in rectangular coordinates, then convert the equation so obtained again to polar coordinates.

In general:

$$E_{\text{Polar}} = A / \pm \alpha^\circ$$

$$E_{\text{Rect.}} = A (\cos \alpha^\circ \pm j \sin \alpha^\circ)$$

$$E_R = 100 (\cos 60^\circ + j \sin 60^\circ) = 50 + j 86.6$$

In general:

$$E_{\text{Rect.}} = B \pm j C$$

$$E_{\text{Polar}} = \sqrt{B^2 + C^2} / \tan^{-1} \frac{C}{B}$$

$$E_P = \sqrt{50^2 + 86.6^2} / \tan^{-1} \frac{86.6}{50} = 100 / +60^\circ$$

A graphic solution of this problem is shown in Fig. 5. As will be demonstrated presently, an ability to convert vector equations from polar to rectangular and from rectangular to polar coordinates, with ease, is of fundamental importance in the solution of problems.

In order for the operations of addition and subtraction to be performed on vectors, the notation must be rect-

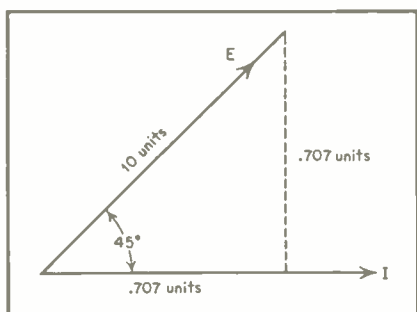

Fig. 4. Voltage leading current by 45°.

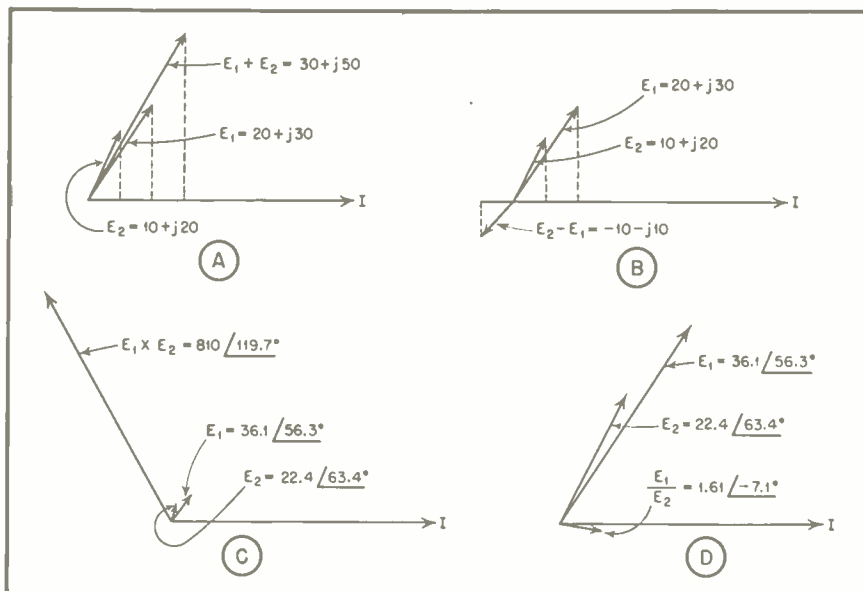

Fig. 6. Vectors resolved from the examples (a), (b), (c) and (d) below.

angular; for the operations of multiplication and division, the notation must be polar. The following examples should suffice to show the procedures followed:

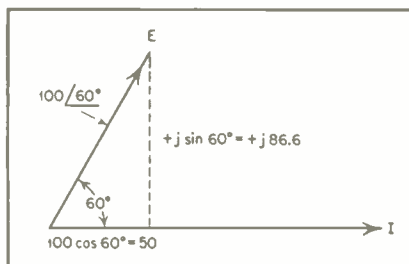

Fig. 5. Example of vector conversion.

- Add $E_1 = 20 + j 30$ to $E_2 = 10 + j 20$.
- Subtract $E_1 = 20 + j 30$ from $E_2 = 10 + j 20$.
- Multiply $E_1 = 20 + j 30$ by $E_2 = 10 + j 20$.
- Divide $E_1 = 20 + j 30$ by $E_2 = 10 + j 20$.

(a) In general:

$$E_1 + E_2 = (A + jB) + (C + jD)$$

$$= (A + C) + j(B + D)$$

$$\frac{E_1 = 20 + j 30}{E_2 = 10 + j 20}$$

$$E_1 + E_2 = 30 + j 50$$

- (b) In general, the procedure is to change signs and add, therefore:

$$\frac{E_2 = 10 + j 20}{-E_1 = -20 - j 30}$$

$$E_2 - E_1 = -10 - j 10$$

- (c) The vectors must first be expressed in polar coordinates as follows:

$$E_1 = 20 + j 30 = \sqrt{20^2 + 30^2} / \tan^{-1} \frac{30}{20} = \frac{36.1}{56.3^\circ}$$

$$E_2 = 10 + j 20 = \sqrt{10^2 + 20^2} / \tan^{-1} 10 = \frac{22.4}{63.4^\circ}$$

In general:

$$E_1 \times E_2 = \frac{A}{\alpha_1} \times \frac{B}{\alpha_2} = \frac{AB}{\alpha_1 + \alpha_2}$$

$$E_1 \times E_2 = 36.1 \times 22.4 / 56.3^\circ + 63.4^\circ = \frac{810}{119.7^\circ}$$

- (d) The polar expressions can be obtained from part (c).

In general:

$$\frac{E_1}{E_2} = \frac{A / \alpha_1}{B / \alpha_2} = \frac{A}{B} / \alpha_1 - \alpha_2$$

$$\frac{E_1}{E_2} = \frac{36.1}{22.4} / 56.3^\circ - 63.4^\circ = 1.61 / -7.1^\circ$$

Fig. 6 shows the relationships of the vectors during these operations.

Needless to say, the mathematics in the previous examples can be carried out with a slide rule in a fraction of the time required to employ tables, multiplication, and long division. Since the physical constants of condensers, coils, transformers and vacuum tubes are usually correct to only two places, the three-place accuracy of a slide rule is sufficient to solve virtually all problems encountered. Another time-saver is a Polar-Rectangular Conversion Chart, obtainable at most bookstores handling engineering supplies, from which answers may be obtained without manipulating complicated mathematical expressions.

Since the purpose of this article is to explain vector algebra rather than to examine the behavior of alternat-

ing currents flowing through impedance networks, the derivations of the following general statements and formulas will not be given.

The current flowing through a theoretically pure resistance (non-inductive) across which a sine wave of voltage has been impressed, will be a sine wave of similar shape having 0° of lead or lag with respect to the voltage (exactly in phase). The current flowing through a theoretically pure inductance (no resistance) will lag the impressed voltage by exactly 90°, and the current flowing through a theoretically pure capacitance (no leakage) will lead the impressed voltage by 90°. We can see that the reactance component (inductive or capacitive) of any circuit will be represented by the *j* quantity previously mentioned, since it will be 90° different in phase relationship from the resistive component. Inductive and capacitive reactances are computed with the following formulas:

$$X_L = 2\pi f L$$

$$X_C = \frac{1}{2\pi f C}$$

Where X_L is inductive reactance in ohms
 X_C is capacitive reactance in ohms
 f is frequency in cycles per sec.
 $\pi = 3.1416$
 L is inductance in Henries
 C is capacity in Farads

In general practice, an inductance without resistance, or a capacitance without leakage is never found. For this reason, coils and condensers, in exact applications, are always represented with a series or parallel resistance. When such a combination exists, there is a phase shift from the 90° lead or lag, which becomes greater

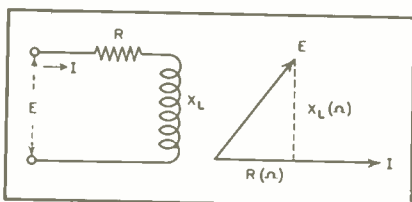

Fig. 7. Current and voltage relations with an imperfect inductance.

as the resistance increases. The impedance offered to the flow of current through an imperfect coil or condenser is drawn vectorially as shown in Fig. 7.

Circuit Problems

The following problems should serve to show the solution of several general a.c. circuits.

1) Determine the amount and phase angle of the current which will flow through a 2 henry choke having an in-

ternal resistance of 200 ohms, if the applied voltage is 100 volts at 60 cycles.

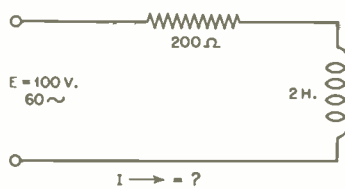

$$X_L = 2\pi f L = 6.28 \times 60 \times 2 = 754\Omega$$

$$Z = R + jX = 200 + j754 =$$

$$\sqrt{200^2 + 754^2} / \tan^{-1} \frac{754}{200} = 780 / +75.3^\circ$$

From Ohm's Law,

$$I = \frac{E}{Z} = \frac{100 / 0^\circ}{780 / +75.3^\circ} = 0.128 / -75.3^\circ \text{ Vector Amps.}$$

Fig. 8 shows a vector diagram of this solution.

2) An inductance and capacitance are connected in series as shown. What current will flow when the frequency of the applied voltage is 60 cycles?

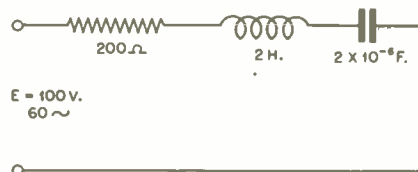

$$X_L = 2\pi f L = 6.28 \times (60) \times 2 = 754\Omega$$

$$X_C = \frac{1}{2\pi f C} = \frac{1}{6.28 \times 60 \times 2 \times 10^{-6}} = 1330\Omega$$

$$X = X_L - X_C = 754 - 1330 = -576\Omega$$

$$Z = R + jX = 200 - j576 =$$

$$\sqrt{200^2 + 576^2} / \tan^{-1} \frac{-576}{200} = 610 / -70.9^\circ$$

$$I = \frac{E}{Z} = \frac{100 / 0^\circ}{610 / -70.9^\circ} = .164 / +70.9^\circ \text{ Vector Amps.}$$

Had the applied voltage been the unknown in the above examples, a manipulation of the Ohm's Law equation would have led to a ready solution.

The solution of parallel circuits follows the same general principle as does that of series circuits. The only new formula which must be introduced is the parallel impedance equation. The total impedance offered by a series of networks in parallel can be found by the following formula:

$$\frac{1}{Z_T} = \frac{1}{Z_1} + \frac{1}{Z_2} + \frac{1}{Z_3} + \dots$$

This equation, it should be noted, is the same as that derived for parallel resistances.

3) Three impedance branches are connected as shown in the diagram. When the current is equal to 2.18 / -26.8° Vector Amps, what is the applied voltage?

$$Z_1 = 10 + j2\pi \times 1000 \times 0.002 = 10 + j12.6$$

$$Z_2 = 30 - j \frac{1}{2\pi \times 1000 \times 4 \times 10^{-6}} = \frac{30 - j39.8}{49.8 / -53^\circ}$$

$$Z_3 = 20 + j2\pi \times 1000 \times 0.004 = \frac{20 + j25.1}{32.1 / 51.4^\circ}$$

The impedance offered by Z_2 and Z_3 will equal

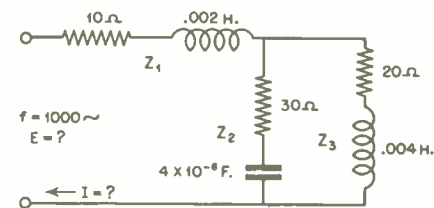

$$\frac{1}{Z} = \frac{1}{Z_2} + \frac{1}{Z_3} = \frac{Z_2 + Z_3}{Z_2 Z_3}$$

$$Z = \frac{Z_2 Z_3}{Z_2 + Z_3}$$

Then, since impedances in series add, the total impedance will be:

[Continued on page 44]

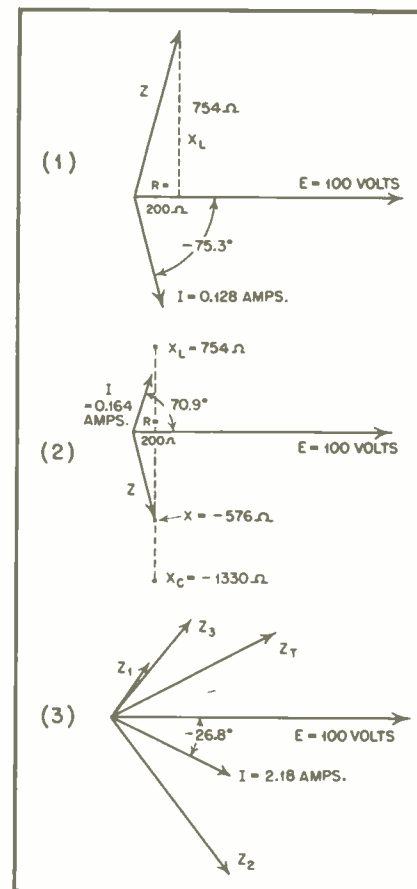

Fig. 8. Vector diagrams of problems (1), (2) and (3).

RADIO DESIGN WORKSHEET

No. 8—POWER AND GAIN

TRANSMISSION GAIN

Problem 1: Establish the expression relating transmission gain due to the insertion of an ideal transformer between two resistances, the values of which are in ratio N .

Solution: An ideal transformer may be defined as a transducer which neither stores nor dissipates energy.

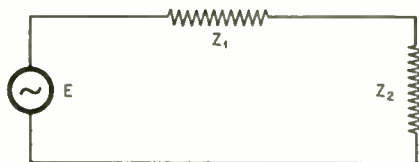

Fig. 1.

Assume the impedances in question are Z_1 and Z_2 . If it is assumed that Z_1 is the source impedance and Z_2 the sink impedance, as in Fig. 1, then the power delivered by source voltage E to sink impedance Z_2 is:

$$I = \frac{E}{Z_1 + Z_2}$$

The power dissipated in Z_2 will be:

$$P = Z_2 I^2 = \frac{Z_2 E^2}{(Z_1 + Z_2)^2}$$

but

$$N = \frac{Z_2}{Z_1}$$

substituting, we have:

$$P = \frac{Z_2 E^2}{Z_1^2 (N + 1)^2} = \frac{E^2}{Z_1 (N + 1)^2}$$

Now let an ideal transformer be inserted between Z_1 and Z_2 , as in Fig. 2.

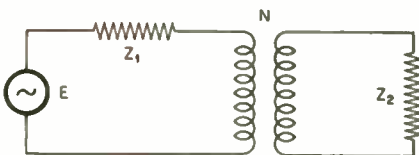

Fig. 2.

The primary current will be:

$$I' = \frac{E}{Z_1 + Z_2/N} = \frac{E}{2Z_1}$$

Since the impedance reflected into the primary by Z_2 will be $Z_2/N = Z_1$ the power dissipated in the impedance reflected into the primary of the transformer will be:

$$P' = \frac{NZ_1 E^2}{4Z_1^2} = \frac{NE^2}{4Z_1}$$

$$\frac{P'}{P} = \frac{E^2}{4Z_1} \times \frac{Z_1(N+1)^2}{NE^2} = \frac{(N+1)^2}{4N}$$

The power gain in db will therefore be:

$$\text{Gain in db} = 10 \log_{10} \frac{P'}{P} = 10 \log_{10} \frac{(N+1)^2}{4N}$$

From the above discussion it is evident that an ideal transformer is equivalent to terminating the source voltage in a resistance Z_2/N . If the transformer ratio is proper, then:

$$N = \frac{Z_2}{Z_1}$$

and

$$Z_1 = \frac{Z_2}{N}$$

Let us take an actual example: Suppose the source impedance were resistive

Gain due to insertion of ideal transformer between source and sink, the impedances of which are in ratio N

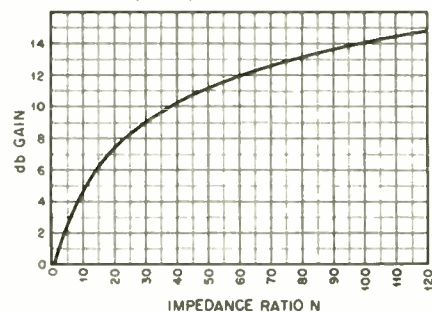

Fig. 3.

and of value A , and the sink impedance were resistive and of impedance Y , so that: $Y = 3A$. Then if an ideal transformer of impedance ratio 3 were inserted between source and sink, maximum power would be delivered to the load; i.e.,

$$P_1 = \frac{E^2}{4A}$$

If no transformer were used, the delivered power would be:

$$P_2 = \frac{3E^2}{16A}$$

Consequently: $P_1/P_2 = 1.33$; i.e., the power will be increased about 33% or 1.2 db. From additional data of this type, the curve of Fig. 3 would result.

POWER AND LOAD

Problem 2: Show that a generator of power will deliver maximum power to a load when the impedance of the load

is equal in magnitude and in phase opposition to the impedance of the generator.

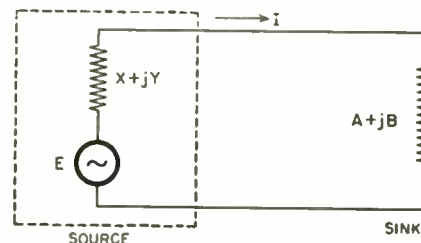

Fig. 4

Solution: The problem is stated in the circuit of Fig. 4 wherein the impedance of the generator equals $X+jY$, the impedance of the load equals $A+jB$, the current is I and the generator voltage E , where $j = \sqrt{-1}$. Then:

$$I = \frac{E}{(X+A) + j(Y+B)}$$

$$\text{Received power} = \frac{AE^2}{[(X+A) + j(Y+B)]^2}$$

$$W = AI^2 = \frac{AE^2}{[(X+A) + j(Y+B)]^2}$$

The magnitude of the vector in the denominator of the preceding expression for W is:

$$(X+A)^2 + (Y+B)^2$$

Whence:

$$W = \frac{AE^2}{(X+A)^2 + (Y+B)^2} \quad (1)$$

Differentiating the right-hand side of equation (1) with respect to A and equating to zero to solve for maximum power, we have:

$$\frac{\partial [(X+A)^2 + (Y+B)^2]}{\partial (X+A)^2} = AE^2 \frac{\partial [(X+A)^2 + (Y+B)^2]}{\partial [(X+A)^2 + (Y+B)^2]}$$

$$\frac{\partial [(X+A)^2 + (Y+B)^2]}{\partial (X+A)^2} = 2E^2 A (X+A) \delta A$$

$$A^2 = X^2 + (Y+B)^2 \quad (2)$$

Differentiating equation (1) with respect to B and equating to zero yields:

$$0 = 2E^2 A (Y+B)$$

or:

$$Y = -B \quad (3)$$

Substituting (3) in (2) yields:

$$A^2 = X^2$$

or:

$$A = X$$

This solution is obvious from a consideration of simple fundamentals. It is evident that if the generator impedance consisted of inductance and resistance in series that more power

[Continued on page 18]

could be drawn from the generator if the inductance were resonated with a series load capacity. That is, when $Y = -B$.

Assuming the generator impedance to be resonated by the load, then the impedance of both generator and load will be resistive. The optimum load impedance may then be determined by trial. First let:

$$A_1 = \frac{X}{2}$$

$$I_1 = \frac{2E}{3X}$$

$$W_1 = I_1^2 A = I_1^2 \frac{X}{2} = \frac{4E^2}{9X^2} \cdot \frac{X}{2} = \frac{2E^2}{9X}$$

Next let:

$$A_2 = X$$

$$I_2 = \frac{E}{2X}$$

$$W_2 = \frac{E^2}{4X}$$

Thirdly let:

$$A_3 = 2X$$

$$I_3 = \frac{E}{3X}$$

$$W_3 = \frac{2E^2}{9X}$$

Obviously:

$$P_2 > P_1$$

$$P_3 > P_2$$

and:

$$P_1 = P_3$$

Thus it is evident that we have located approximately the value of A in terms of X for maximum power transfer. We might now proceed by choosing values of A closer to X until sufficient data were accumulated to plot a curve of $W = f(A)$. It would then be found that the curve would have a maximum at: $X = A$.

SPEAKER CONE DESIGN

Problem 3: The fabrication of the paper diaphragm of a direct radiator loudspeaker usually starts with a flat

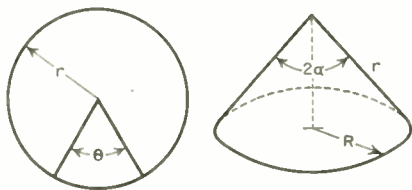

$$\theta = 2\pi(1 - \sin \alpha)$$

Fig. 5.

circular paper sheet from which a sector is removed. Determine the central angle of such a sector in terms of the apex angle of the cone diaphragm.

Solution: Referring to Fig. 5: Let the sector central angle be θ ; let the apex angle of the cone be 2α .

Area of circle is πr^2

Area of sector is $\frac{\pi r^2 \theta}{2}$ (θ in radians)

Area of circle minus area of sector is $\pi r^2 - \frac{\pi r^2 \theta}{2}$

Area of circle minus area of sector is equal to lateral area of cone. Lateral area of cone is $\pi r R$

$$R = r \sin \alpha$$

Whence we have:

$$\pi r^2 - \frac{\pi r^2 \theta}{2} = \pi r R = \pi r^2 \sin \alpha$$

$$r^2 \left(\pi - \frac{\theta}{2} \right) = r^2 \sin \alpha$$

$$2\pi - \theta = 2\pi \sin \alpha$$

And:

$$\theta = 2\pi(1 - \sin \alpha)$$

which is the formula desired.

$2\alpha^\circ$	0	90	100	120	140	160	180
θ	360	105.43	83.6	48.18	21.6	5.39	0

A plot of this relation is shown in Fig. 6. Customarily a frustrum of a right circular cone is used as the diaphragm. This does not alter the computation of the sector to be removed but it does require that a circle of the required diameter be pierced from the center of the flat circular sheet.

SERIES RESONANT CIRCUIT

Problem 4: Determine the following

from the series resonant circuit Fig. 7:

- 1) Resonant frequency; 2) $Q = \frac{\omega L}{R}$;
- 3) Bandwidth at 70% response; 4) Impedance at resonance; 5) Voltage E across inductance at resonance.

Solutions:

1) Resonant frequency $f = \frac{1}{2\pi\sqrt{LC}}$

$$f = \frac{1}{2\pi\sqrt{10^{-4} \times 10^{-10}}} = \frac{10^7}{2\pi} = 1600 \text{ kc.}$$

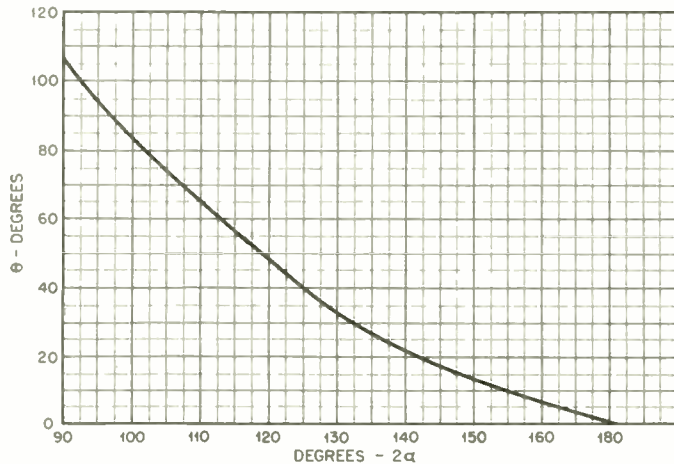

Fig. 6.

2) $Q = \frac{\omega L}{R} = \frac{2\pi \times 16 \times 10^3 \times 100 \times 10^{-6}}{10} = \frac{10}{2\pi \times 16} = 100$

3) Bandwidth $\Delta f = \frac{f}{Q} = \frac{16 \times 10^3}{100} = \frac{16000}{100} = 160 \text{ kc.}$

4) Impedance at resonance = $R = 10 \text{ ohms}$

since $2\pi fL = \frac{1}{2\pi fC}$ as a condition of resonance

5) $E_1 = 2\pi fLI = \frac{2\pi \times 16 \times 10^3 \times 100 \times 10^{-6} \times I}{100 \times 10^{-6} \times I} = 1000 I$

But $I = \frac{E}{R} = \frac{10}{10} = 1 \text{ ampere}$

Therefore $E_1 = 1000 \text{ volts}$

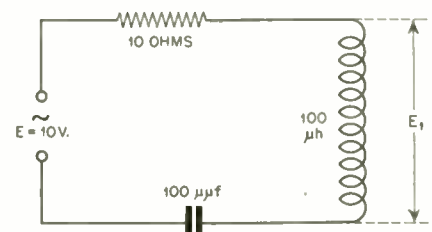

Fig. 7.

Q. & A. STUDY GUIDE

C. RADIUS

RCA Institutes

VACUUM TUBES—1

FILAMENT CHARACTERISTICS

1. What is the meaning of electron emission? (II-133).

Electron emission is the evaporation of the free electrons moving between the fixed atoms which make up the metal of the filament or cathode. If heat energy is used to liberate the electrons, the phenomena is called *thermionic emission* and follows the same laws governing the evaporation of water molecules upon boiling.

2. Is a tungsten filament operated at a higher or lower temperature than a thoriated filament? Why? (V-43).

3. What types of vacuum-tube filaments may be reactivated? (II-159).

4. What type of vacuum-tube emitting surfaces respond to reactivation? (V-41).

5. How may vacuum-tube filaments be reactivated? (II-157).

6. Describe how reactivation may be accomplished. (V-42).

7. Why is it impractical to reactivate oxide-coated filament vacuum tubes? (V-40).

8. Why is it important to maintain transmitting tube filaments at recommended voltages? (II-156).

Vacuum tubes for communication equipment use three types of materials to supply a stream of electrons. High-power transmitting tubes use pure tungsten (W) filaments, some as large

THE "GUIDE" IN NEW FORM

★ Beginning this month, we are presenting the "Q. & A. Study Guide" in a new and more convenient form. Questions revolving around one general topic are grouped together, and a single, detailed answer given for the group. By this means the reader is better able to grasp the full significance of each question, and can readily form his own individual answers.

It will be noted that the original sequence of questions as they appear in the FCC Study Guide, is not followed; rather, questions are gathered under specific headings, such as "Vacuum Tubes"; but for the convenience of those who may wish to locate the questions in the original Study Guide, the Element and Question numbers appear after each question. Thus, (II-133) refers to Question 133 in Element II, and (V-43) refers to Question 43 in Element V.

This system of presentation also eliminates the monotony of duplications, for the original Study Guide poses many similar questions in much the same form, but not necessarily in the same Element.

Material for the Q. & A. Study Guide is now being prepared by Mr. Clarence Radius, of RCA Institutes, Inc., and the new method of presentation was developed by him.—*Editor.*

as one-half inch in diameter and a couple of feet in length, operated around 2500 degrees F. It is necessary to use a pure metal to obtain a copious supply of electrons, and to provide long filament life. It requires 4.5 watts of power to evaporate 6.25×10^{18} electrons per second (1 ampere). This is com-

puted from the "work function" of the metal which is a measure of the energy necessary to liberate a given amount of electric charge.

Lower-power transmitting tubes use tungsten filaments coated and impregnated with thorium — referred to as *thoriated tungsten*. The electrons are emitted from the thorium which gives up its free electrons at a lower temperature, around 2000 degrees F. Thorium will deliver 6.25×10^{18} electrons per second with a power consumption of only 2.6 watts. Its work function is less than that of pure tungsten.

Since the electrons come from the thorium, the almost monoatomic layer of thorium on the tungsten eventually will be depleted, and emission will drop. It is obvious that this condition will occur sooner if the filament is operated at a higher than normal temperature, as a result of excessive filament voltage. The expected life of the tube can be increased materially by operating with filament voltages slightly below normal.

Tubes in which the surface thorium is lost may be reactivated by bringing some of the impregnated thorium to the surface. To do this will require more energy than is expended in normal operation. All leads except those of the filament should be removed. For large tubes the filament is operated at 30% above normal voltage for a period of 10 minutes, followed by one or two hours of operation at normal voltage. For smaller tubes the filament is operated at, say, 2.5 times normal voltage for 20 seconds, then at 20% above normal voltage for one hour.

General receiving-type tubes use an emitter known as barium and strontium oxide deposited on a metal such as nickel. These oxides will liberate their free electrons at around 1500 degrees F.; hence the cathodes are known as dull emitters. It requires only 1 watt to evaporate 6.25×10^{18} electrons. This material is used in both the filamentary (wire) and indirectly heated (sleeve) cathodes. Since the emitter material is merely deposited on the pure metal base, these cathodes cannot be reactivated when the surface layer is depleted.

From this discussion it is apparent
[Continued on page 36]

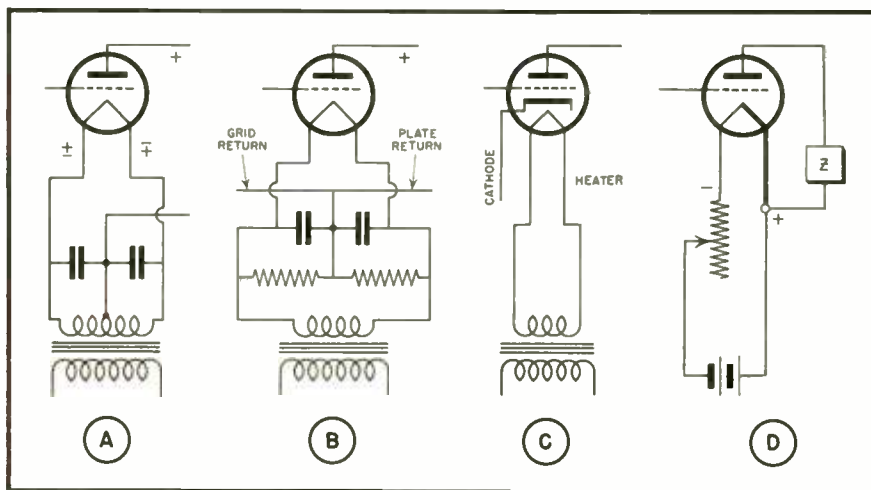
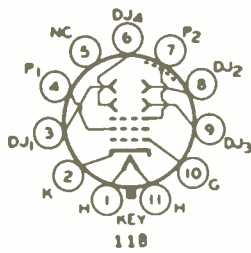

Fig. 1. Filament and heater connections for a.c. and d.c. operation.

NEW TUBE TYPES

2AP1 CATHODE-RAY TUBE

The 2AP1 is a high-vacuum, cathode-ray tube similar to type 902 except that it has separate leads to all deflecting electrodes and the cathode, employs a magnal 11-pin base, and can be operated with higher anode voltages. Socket connections are shown below.



Tentative Characteristics

Heater Voltage	Coated Unipotential Cathode	6.3 a-c or d-c volts
Heater Current		0.6 amp.
Focusing Method		Electrostatic
Deflection Method		Electrostatic
Electrodes DJ ₁ and DJ ₂ (upper):		nearest to screen
DJ ₁ is on same side of tube as pin No. 4		
Electrodes DJ ₃ and DJ ₄ (lower):		nearest to base
DJ ₃ is on same side of tube as pin No. 1		
Phosphor	No. 1	
Fluorescence	Green	
Persistence	Medium	
Direct Interelectrode Capacitances (Approx.):		
Control Electrode (Grid) to All Other Electrodes	8.0	μμf
Cathode to All Other Electrodes	5.5	μμf
DJ ₁ to DJ ₂	0.6	μμf
DJ ₃ to DJ ₄	1.1	μμf
DJ ₁ to All Other Electrodes	8.5	μμf
DJ ₂ to All Other Electrodes Except DJ ₁	8.0	μμf
DJ ₃ to All Other Electrodes Except DJ ₄	4.6	μμf
DJ ₄ to All Other Electrodes Except DJ ₃	7.5	μμf
DJ ₁ to All Other Electrodes Except DJ ₂	3.6	μμf

Maximum Ratings

Maximum Ratings Are Absolute Values

Anode No. 2 (High-Voltage Electrode) Voltage	1100 max. volts
Anode No. 1 (Focusing Electrode) Voltage	500 max. volts
Grid (Control Electrode) Voltage	Never positive
Peak Voltage Between Anode No. 2 and any Deflecting Electrode	660 max. volts
D-C Heater-Cathode Potential ¹	125 max. volts
Grid-Circuit Resistance	1.5 max. megohms
Impedance of Any Deflecting-Electrode Circuit at Heater-Supply Frequency	1.0 max. megohm
Typical Operation:	
Anode No. 2 Voltage ²	500 1000 volts
Anode No. 1 Voltage for Focus at 75% of Grid	125 250 volts
Voltage for Cut-Off (Approx.) ³	-30 -60 volts
Grid Voltage for Cut-Off ⁴	
Deflection Sensitivity:	
DJ ₁ and DJ ₂	0.220 0.110 mm/volt d.c.
DJ ₃ and DJ ₄	0.260 0.130 mm/volt d.c.
Deflection Factor: ⁵	
DJ ₁ and DJ ₂	115 230 volts d.c./in.
DJ ₃ and DJ ₄	98 196 volts d.c./in.

¹ With heater negative. Cathode should be connected to one side or to the mid-tap of the heater-transformer winding.
² Brilliance and definition decrease with decreasing anode No. 2 voltages. In general, anode No. 2 voltage should be not less than 500 volts.
³ Individual tubes may require between +10% and -45% of these values with grid voltage between zero and cut-off.
⁴ Visual extinction of a stationary focused spot. For cut-off, supply should be adjustable to ±50% of this value.
⁵ Subject to variation of ±20 per cent.

SPOT POSITION

The undeflected focused spot will fall within a 10-mm square centered at the geometric center of the tube face and having one side parallel to the trace produced by DJ₁ and DJ₂. Suitable test conditions are: anode No. 2 voltage, 1000 volts; anode No. 1 voltage adjusted for focus; deflecting-electrode resistors, 1 megohm each, connected to anode No. 2; the tube shielded from all extraneous fields. To avoid damage to the tube, make the test with grid voltage near cut-off.

Tentative Characteristics—6AG5

Heater Voltage (A.C. or D.C.)	6.3	Volts
Heater Current	0.3	Ampere
Direct Interelectrode Capacitances (Approx.): ^a		
Grid to Plate [C _{G1P}]	0.025 max.	μμf
Input [C _{G1} (h + k & g ₃ & internal shield + g ₂)]	6.5	μμf
Output [C _P (h + k & g ₃ & internal shield + g ₂)]	1.8	μμf
Bulb Base	T-5-1/2	Miniature Button 7-Pin ^b
Mounting Position	Any	

Maximum Ratings Are Design-Center Values

Amplifier

Plate Voltage	300 max.	Volts
Screen Voltage	150 max.	Volts
Plate Dissipation	2 max.	Watts
Screen Dissipation	0.5 max.	Watt

TYPICAL OPERATION and CHARACTERISTICS—Class A₁ Amplifier

Plate Voltage	100	125	250	Volts
Screen Voltage (Grid No. 2)	100	125	150	Volts
Cathode-Bias Resistor	100	100	200	Ohms
Plate Resistance (Approx.)	0.3	0.5	0.8	Megohm
Transconductance	4750	5100	5000	Micromhos
Grid Bias for Plate Current = 10 μamp.	-5	-6	-8	Volts
Plate Current	5.5	7.2	7	Milliamperes
Screen Current	1.6	2.1	2	Milliamperes

¹ The center hole in sockets designed for this base provides for the possibility that this tube type may be manufactured with the exhaust-tube tip at the base end. For this reason, it is recommended that in equipment employing this tube type, no material be permitted to obstruct the socket hole.
² With no external shield.

6AG5 R-F PENTODE

The 6AG5 is an r-f pentode of the Miniature type with a sharp cut-off characteristic and a high value of transconductance. It is useful in compact, light-weight equipment as an r-f amplifier up to about 400 megacycles, and as a high-frequency, intermediate amplifier. It has low input capacitance and low output capacitance. Socket connections are shown in Fig. 1.

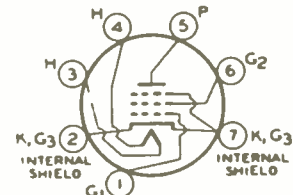

7B0

Fig. 1.

6J6 TWIN TRIODE

The 6J6 is a heater-cathode type of Miniature tube having two grids and two plates with a common cathode. The twin units may be operated in parallel or in push-pull. With a push-pull arrangement for the grids, and with the plates in parallel, the 6J6 is

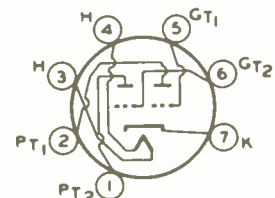

7Bf

Fig. 2.

particularly applicable as a mixer at frequencies as high as 600 megacycles. It is also useful as an oscillator. Socket connections are shown in Fig. 2.

Tentative Characteristics—6J6		
Heater Voltage (A.C. or D.C.) ¹	6.3	Volts
Heater Current	0.45	Amperes
Direct Interelectrode Capacitances—Each Unit (Approx.): ²		
Grid to Plate [C_{gp}]	1.6	μf
Grid to Cathode [C_{gk} (h + k)]	2.2	μf
Plate to Cathode [C_{pk} (h + k)]	0.4	μf
Bulb	T-5- $\frac{1}{2}$	
Base	Miniature Button 7-Pin ³	
Mounting Position	Any	

Maximum Ratings Are Design-Center Values

A-F Amplifier		
Plate Voltage	150 max.	Volts
Plate Dissipation (Each Unit)	1.5 max.	Watts
CHARACTERISTICS—Class A ₁ Amplifier—Each Unit		
Plate Voltage	100	Volts
Cathode Bias Resistor ⁴	50 ⁴	Ohms
Plate Current	8.5	Milliamperes
Amplification Factor	32	
Plate Resistance	6000	Ohms
Transconductance	5300	Micromhos

R-F Power Amp. & Osc.—Class C Tel.		
D-C Plate Voltage	150 max.	Volts
D-C Grid Voltage	-40 max.	Volts
D-C Plate Current (per unit)	15 max.	Milliamperes
D-C Grid Current (per unit)	8 max.	Milliamperes
D-C Plate Input (per unit)	2.25 max.	Watts
Plate Dissipation (per unit)	1.5 max.	Watts

TYPICAL OPERATION AT MODERATE FREQUENCIES IN PUSH-PULL—Both Units.⁵
(Key-down conditions per tube without modulation)

D-C Plate Voltage	150	Volts
D-C Grid Voltage		
From a fixed supply of	-10	Volts
From a grid resistor of	625	Ohms
From a cathode resistor of	220	Ohms
D-C Plate Current	30	Milliamperes
D-C Grid Current (Approx.)	16	Milliamperes
Driving Power (Approx.)	0.35	Watt
Power Output (Approx.)	3.5	Watts

¹ In circuits where the cathode is not directly connected to the heater, the potential difference between heater and cathode should be kept as low as possible.

² With no external shield.

³ Under maximum rated conditions, the resistance in the grid circuit should not exceed 0.5 megohm with cathode bias. Operation with fixed bias is not recommended.

⁴ Value is for both units operating at the specified conditions.

⁵ Approximately 1.5 watts can be obtained when the 6J6 is used at 250 mc as a push-pull oscillator with a plate voltage of 150 volts, with maximum rated plate dissipation, and with a grid resistor of 2000 ohms common to both units.

⁶ The center hole in sockets designed for this base provides for the possibility that this tube type may be manufactured with the exhaust-tube tip at the base end. For this reason, it is recommended that in equipment employing this tube type, no material be permitted to obstruct the socket hole.

5R4-GY FULL-WAVE RECTIFIER

The 5R4-GY is a coated-filament type of full-wave, high-vacuum rectifier having a maximum peak inverse voltage rating of 2800 volts, a peak

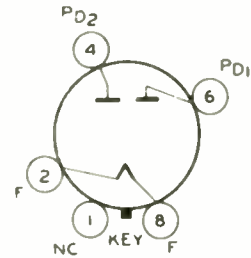

G-5T

Fig. 3.

plate current rating of 650 milliamperes, and a maximum d-c output current rating of 175 milliamperes when a choke-input type of filter is used. The 5R4-GY has a micanol base. Socket connections are shown in Fig. 3.

"AUDIO" WEIGHING SCALE

The "audio" scale, making it possible for the blind to weigh rapidly and accurately and opening new industrial fields to them, was demonstrated recently at the American Foundation for the Blind, 15 West 16th Street, New York. The scale operates on the airplane radio beam principle, giving the audible signal "A" as long as the scale shows under the correct weight, and the signal "N" if it registers over. Correct weight is signalled by an unbroken buzz.

Alternating current of 1000 cycles flows in a tuneable double branch circuit, with an earphone coupling transformer common to both branches. A motor-driven contactor switches the current alternately to the two branches so that the intermeshed "A" and "N" pulses are applied respectively to the minus and plus fixed plates of the scale indicator balancing condenser. At the desired weight, both signals are heard synchronized.

In war plants, the scale has such uses as weighing out specific amounts of powder for fuses, mica for radio mechanisms, and buttons for uniforms. Blind operators using it are able to package phonograph needles, 25 or 50 to a pack, more rapidly than by counting. It is also expected to prove useful to sighted persons who have to work in the dark, as in film plants, or who must concentrate on such operations as filling narrow-mouthed containers to a net weight content.

J. O. Kleber, engineer of the Foundation; H. D. Bennett, President of the Toledo Scale Company; and Lawrence Williams, chief engineer, directed the demonstration.

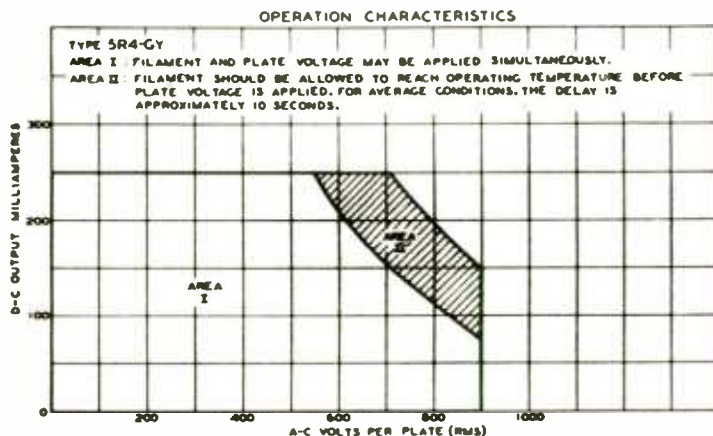

Fig. 4.

Tentative Characteristics—5R4-GY

Filament Voltage (A.C.) ¹	5.0	Volts
Filament Current	2.0	Amperes
Base	Medium Shell Octal 5-Pin, Micanol	
Mounting Position	Vertical ²	

Maximum Ratings Are Design-Center Values

Full-Wave Rectifier

Peak Inverse Voltage (No-Load Conditions)	2800 max.	Volts
Peak Plate Current per Plate	650 max.	Milliamperes
WITH CONDENSER-INPUT FILTER:		
A-C Plate Voltage per Plate (RMS) { Full Load	700	900
{ No Load	750	1000
Total Effective Plate-Supply Impedance per Plate ³	125	575
D-C Output Current	250 max.	150 max.
WITH CHOKE-INPUT FILTER:		
A-C Plate Voltage per Plate (RMS) { Full Load	750	950
{ No Load	850	1000
Input-Choke Inductance	5 min. 10 min.	Henries
D-C Output Current	250 max.	175 max.

¹ See curve of Fig. 4 for conditions necessitating delay in application of plate voltage until filament has reached operating temperature.

² Horizontal operation is permissible if pins 1 and 4 are in a vertical plane.

³ When a filter-input condenser larger than 4 μf is used, it may be necessary to use more plate-supply impedance than the value shown to limit the peak plate current to the rated value.

NEW PRODUCTS

NEW AIRCRAFT RELAY

The B-2-A relay described is one of a series in Guardian Electric's new line of units which have been designed for remote control of aircraft electrical

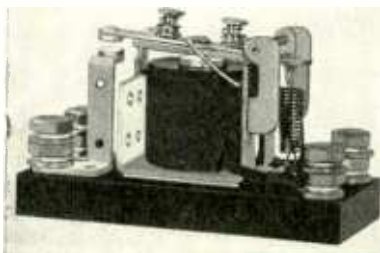

circuits. Built to U. S. Army Air Force specifications, unit has a contact rating of 25 amperes continuous and 100 amperes surge at 25 volts d.c. It has single pole, single throw, normally open contacts. Weighs 6 ounces.

Manufacturer claims unit has acceleration and vibration resistance over 10 times gravity. Metal parts and heavily plated to withstand 200-hour salt spray test. Designed primarily for aircraft, unit is said to have numerous applications in other industries. Descriptive bulletin and full details are available from Guardian Electric, Dept. B-2-A, 1605 West Walnut St., Chicago, Ill.

★

CARTER AIRCRAFT "MAGMOTOR"

The Carter Motor Company, 1605 Milwaukee Ave., Chicago, announces a new extra light-weight Permanent Magnet Dynamotor for Aircraft use.

Known as the High Capacity Magmotor, the 100-watt models weigh only 4¾ lbs., approximately half the weight of other conventional dynamotors of equal output. The unit measures 5¾"

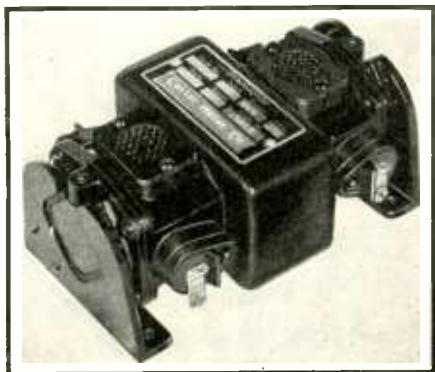

long, 3 11/16" wide, and 2 ½" high. It is available in a wide range of input and output voltages.

Because the conventional field coils have been eliminated, unusually high efficiency, small size, and light weight is possible.

★

SHALLCROSS PER%CENT LIMIT BRIDGE

This is a new instrument for the quick and precise inspection of resistors to determine if they are within the specified percentage tolerance.

The outstanding feature of the device is that a selection of tolerance from 0.25% to 10% can be made, and the plus and minus tolerances may be set individually and independently of each other. For example, the plus may be set at 1% and the minus at 10%, or vice versa, or either tolerance at any percentage required, within the range of the instrument.

The working standard may consist of 6 decades totalling 1,111,110 ohms, in 1-ohm increments.



By setting the independently operated percentage dials to the "M" position, the bridge is instantly ready for use as a Wheatstone Bridge (unity ratio), and the actual resistance of the units under test can be readily measured.

This new No. 621-A Per% Cent Limit Bridge is completely self-contained. A standard No. 6 dry cell furnishes the power for measuring low resistances. For higher resistances, an a.c.-operated rectifier tube supplies the power.

For detailed information, write the Shallcross Mfg. Co., Dept. 28, Collingdale, Penna.

★

SMALL POWER RELAYS

The Allied Control Company announces that their Models BO and BJ Power Relays for flight, firing and communication control have been redesigned to require minimum mounting

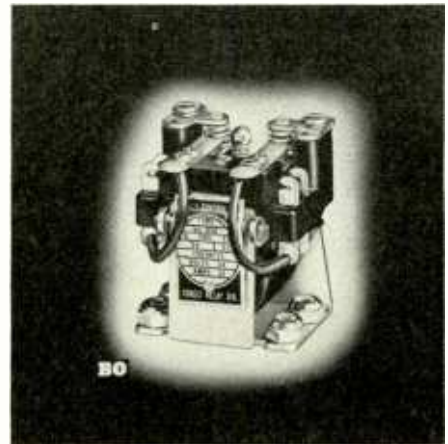

space and to permit variations in their mounting bases to make them widely interchangeable. They are now available with mounting bases of bakelite, screw or shake-proof nut, etc.

The design and construction of Allied Models BO and BJ power relays include easily accessible terminal connections and a semi-balanced armature to withstand vibratory motion with minimum coil power.

The specifications of BO are: contact ratings, non-inductive, 15 amperes for 12 and 24 volts d.c. and 110 volts a.c.; single or double pole, double throw; weights, 4 ounces with screw or shake-proof nut mounting or 7 ounces with bakelite mounting (model [Continued on page 47])

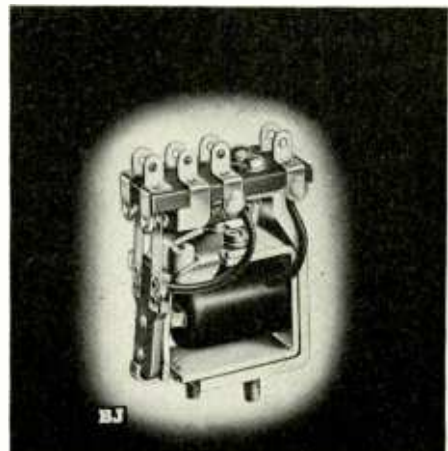

**"HOGARTH IS REALLY HIGH
ON HIS *ECHOPHONE EC-1*"**



Echophone Model EC-1 6 tubes, 3 bands. Tunes from 550 kc. to 30 mc. Beat frequency oscillator. Bandsread logging scale. Self-contained speaker. Electrical bandsread on all bands. AC/DC. 115-125 volts. ECHOPHONE RADIO CO., 201 EAST 26TH ST., CHICAGO, ILLINOIS

THIS MONTH

CARRIER CURRENT SAVES COPPER

A reduction of 85 percent in the amount of copper used in systems to control outdoor and obstruction lighting, and other electrical apparatus at three military bases in North Carolina, Virginia, and New Jersey, is made possible by the use of carrier-current equipment, according to General Electric engineers.

Developed in the G-E Carrier-current Laboratory prior to the present war, the carrier-current equipment used at the military bases is similar to that used by many electric power stations to control street lights and water heaters.

The equipment transmits impulses over the regular power lines at the military bases. These impulses are picked up by receivers which in turn operate relays to turn on or off the current flowing to electric lights, pumps, and other electrical apparatus. Use of this equipment at the military bases eliminated the necessity of running many miles of separate lines of copper cable to control the various electrical circuits.

★

THERMADOR ENTERS TRANSFORMER FIELD

The Thermador Electrical Manufacturing Co., of Los Angeles, manufacturers of electric ranges, water heaters and room heaters, and presently engaged in the production of equipment for the U. S. Navy, have pur-

chased from the Phelps Dodge Corporation the machines and dies used in the past by that corporation for the manufacture of transformers for the radio and electronic fields.

Mr. W. E. Cranston, Vice President and General Manager of Thermador, states that his organization has also obtained the services of the engineers, production manager, winders, etc., originally employed by Phelps Dodge in their transformer division.

The Thermador Transformer Division is now in complete operation, and turning out units for general and special applications.

★

STANCOR HONORS EMPLOYEES

At an elaborate banquet and celebration, held November 24th, at the Standard Club, Chicago, Standard Transformer Corporation acted as host to 105 of its employees who have served the Corporation for five years or more. The event inaugurated the presentation of Honor Awards to members of the Stancor Family. The Honor Awards were silver emblems for those who had served five to nine years, and gold emblems for those who had served the company continuously for ten years or more.

★

HALLICRAFTERS AID SIGNAL CORPS RECRUITING

To encourage Signal Corps enlistment The Hallicrafters Company have



Colonel C. N. Sawyer and William J. Halligan.

devoted a portion of their institutional advertising toward calling attention to the present day enlistment requirements. An enlarged copy of the advertisement was presented to Colonel C. N. Sawyer, Commandment, Signal Schools, 6th Service Command by William J. Halligan of The Hallicrafters Company.

★

SYNTHETIC AUDIO FREQUENCIES

The December meeting of The Radio Club of America held on Thursday, the 10th, in Havemeyer Hall, Columbia University, featured a paper by Louis A. De Rosa, Research Engineer, on "Synthetic High and Low Audio Frequencies for Hi-Fidelity Reproduction."

According to Mr. De Rosa, an analysis of the operation of the human hearing mechanism leads to the conclusion that the ear acts as a translating device and supplies the brain with signal patterns which are, in general, highly distorted versions of the externally-impressed acoustical energy.

By the cognizance of the general rules governing the distortion characteristic of the ear, it is possible to supply the hearing mechanism with sounds consisting principally of externally-generated extraneous products and yet produce natural and apparently distortion-free responses. The ear apparently acts as a narrow band transducer,

[Continued on page 39]



The Thermador Electrical Manufacturing Co. plant, at Los Angeles.



L A C E D W I R I N G H A R N E S S

F O R C O M M U N I C A T I O N S E Q U I P M E N T

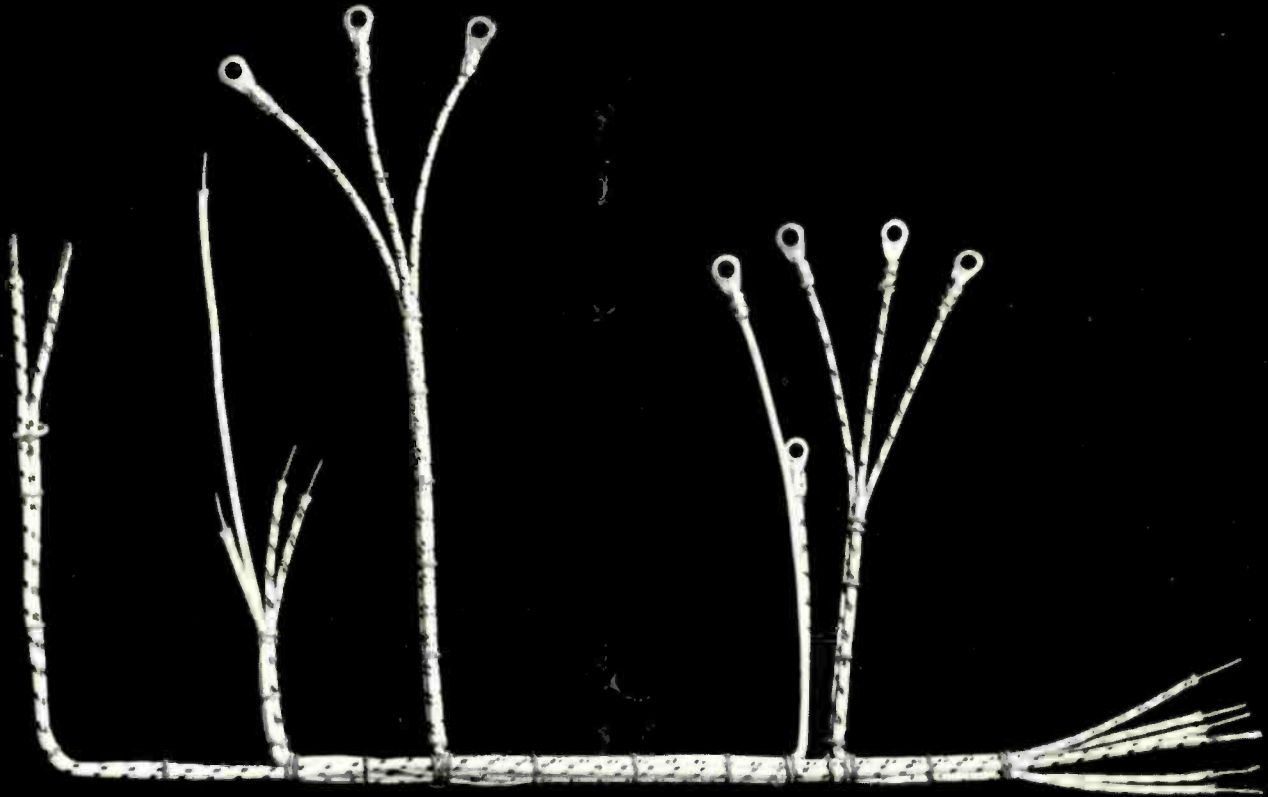

Expedite Wiring Operations

A sure cure for wiring "headaches". Constructed entirely of wires with approved types of color coded insulation, assembled exactly in accordance with your specifications, Lenz Laced Wiring Harnesses will speed up your wiring operations and permit the release of some of

your important labor to other assembly tasks.

Make the Lenz organization a part of your factory. A Lenz Wire engineer will be glad to consult with you on your requirements. Quotations will be gladly furnished on receipt of specifications and sketch.



IN BUSINESS

SINCE 1904

LENZ ELECTRIC MANUFACTURING CO.

1751 NORTH WESTERN AVENUE • CHICAGO, ILLINOIS

RADIO

★ DECEMBER, 1942

25

RADIO BIBLIOGRAPHY

F. X. RETTENMEYER

RCA Manufacturing Co., Inc.

7—REMOTE CONTROL, Part 2

IN PREVIOUS ISSUES:

Aviation Radio, May, 1942
Frequency Modulation, June, 1942
Crystallography, July, 1942
Tubes, August, 1942
Amplification, Detection, Sept. 1942
Filters, Sound, Loudspeakers, Oct. 1942

Control of Electric Loads by Remote Control Relay—J. Cooper—*Modern Power & Engineering*, Vol. 32, 1938, page 20.

Remote Control of Surface Tank-Booster Pump Pressure Regulating Stations—M. B. Cunningham and F. Hermann—*Water Works & Sewerage*, Vol. 85, 1938, page 539.

Moderne Hochfrequenzübertragungen über Hochspannungleitungen—G. Dressler—*Elektrotechnik und Maschinenbau*, Vol. 56, 1938, page 371.

Modern h.f. transmission on h.t. lines; includes discussion of modern installations for remote control.

Ford Power Plant Instrumentation—W. W. Dulmage—*Instruments*, Vol. 11, 1938, page 141.

Empire Telegraph Communication, *The Institute of Electrical Engineers*, (Br.), 1938.

Control Signalling Over Networks—D. R. Gales—*Electrical Times*, Vol. 94, 1938, page 241.

Description of the A.E.G. telecontrol system for controlling street lighting.

La Commande Centralisee Des Sous-Stations de Traction—M. Garreau—*Societe Francais des Electriciens*, Bull., Series 5, Vol. 8, 1938, page 1007.

Centralized control of traction substations.

La Commande Centralisee des Sous-stations de Traction de la ligne Electrifiee de Paris au Mand des Chemins de fer de l'Etat—M. Garreau—*Revue Generale de l'Electricite*, Vol. 43, 1938, page 719.

Reading Wire Elevations by Automatic Telegraphy—D. D. Gross—*Engineering News-Record*, Vol. 120, 1938, page 538.

New High-speed Distance-type Carrier-pilot Relay System—E. L. Harder et al., *AIEE*, Trans., Vol. 57, 1938, page 5.

Möglichkeiten der Fernbedienung bei Anwendung von Siemens—Fernbedienungseinrichtungen nach dem wahlverfahren—W. Henning—*Siemens Zeitschrift*, Vol. 18, 1938, page 402.

Possibilities of remote control by application of Siemens remote control apparatus of the selector system.

Siemens - Fernbedienungseinrichtung nach dem Wahlersystem—W. Henning—*Siemens Zeitschrift*, Vol. 18, 1938, page 255.

Siemens remote control arrangement employing selector switches.

Mystery Control—R. C. Herzog—*Communications*, Vol. 18, October, 1938, page 20.

Versatile Remote-control Circuit: Filament and Plate Control Frequency Changing, Speech Circuit, Monitoring and Overmodulation Indication, on a Two-wire Line—M. L. Hilliard—*QST*, Vol. 2, 1938, July, 1938, page 37.

Radio Telephony for System Control—J. H. Hindman—*Electrical Times*, Vol. 93, 1938, page 777.

Automatic Central Control with Reference to Street Lighting—E. E. Hoadley and H. P. Barker—*Electrician*, Vol. 120, 1938, page 666; abstracts in *Electrical Review*, London, Vol. 122, 1938, page 752; *Engineering*, Vol. 145, 1938, page 631; *Engineer*, Vol. 166, 1938, page 99; *Electrician*, Vol. 120, 1938, page 669; *Electrical Review*, London, Vol. 122, 1938, Page 752; *Engineering*, Vol. 145, 1938, page 631.

Carrier Current Telemeter—S. Jimbo and T. Ito—*Electrotechnical Journal*, Japan, Vol. 2, 1938, page 32.

Ein Einfaches Fernbedienungssystem—S. John and J. Sarge—*Siemens Zeitschrift*, Vol. 18, 1938, page 351.

Die Unterlagerung von fernmess- und Zahlmpulsen auf Fernsprechleitungen—G. Kampahausen—*Siemens Zeitschrift*, Vol. 18, 1938, page 46.

Superposition of remote metering and impulse counting on telephone lines.

Geräte und Verfahren der Fernmessanlagen—H. Kramm—*Zeitschrift für Fernmeldetechnik*, Vol. 19, 1938, Page 1.

Instruments and methods of telemetering.

Das Transkommando system unter besonderer Berücksichtigung der Rick-

wirkung auf des Drehstromnetz—K. Krantwig—*Verband Deutscher Elektrotechniker, Fachberichte*, Vol. 10, 1938, page 1479.

The "Transkommando" system with special reference to the reaction of the three-phase network.

Der Umkehrfernswitcher und die damit verbundene Installationsweise—F. K. Lucan—*Elektrotechnische Zeitschrift*, Vol. 59, 1938, page 261.

Remote reversion switch and its installation for remote control of electric lights.

Telemetering—P. MacGahan—*Electric Journal*, Vol. 35, 1938, page 113.

Remote Control Over Power Mains of Street Lighting, Water Heating, and Other Services—E. M. S. McWhirter—*Electrical Communication*, Vol. 17, 1938, page 107.

Low voltage d.c. bias system.

Applications of the Hot Cathode Gas-filled Triode Valve (Other than Cathode-Pool Types)—E. May—*Electrical Times*, Vol. 94, 1938, page 307.

New Gear for Radio Control Circuit, *QST*, July, 1938, page 44.

New Electric Control System, *Engineer*, Vol. 166, 1938, page 421.

Description of Telecontrol system.

Lichtelektrische Geräte zur Betriebsüberwachung—H. Noack—*Verband Deutscher Elektrotechniker, Fachberichte*, Vol. 10, 1938, page 145.

Photoelectric Devices for supervisory purposes. Novel Automatic Radios Introduced, *New York Times*, June 5, 1938.

Nouveaux Despositifs de Telemesure—J. Pelpel—*Societe Francaise des Electriciens*, Bull., Vol. 8, 1938, page 933.

New methods of telemetering.

Self-checking System of Supervisory Control—M. E. Reagan—*American Institute of Electrical Engineers*, Trans., Vol. 57, 1938, page 600.

Relay Contacts—Their Ailments, *Electronics*, December, 1938, page 29.

Remote Control of a Protective Relay, *QST*, page 47, September, 1938.

Remote Control for Small Pumping Stations, *Public Works*, Vol. 69, 1938, page 53.

Remote Control on D. & R. G. W., *Railway Signaling*, Vol. 31, 1938, page 289.

[Continued on page 29]

★ RELAYS

FROM GUN BLAST HEAT TO ARCTIC COLD

★ Smothered in dust . . . seared by gun blast heat . . . shrouded in fog . . . gripped by stratosphere cold . . . shaken by blasts of bomb and shell . . . these are daily incidents in the life of a relay. Under these conditions Relays by Guardian have already "proved their metal."

THE SERIES 195 RELAY weighs less than an ounce! But don't let its tiny size fool you. It shrugs off the most severe vibrations likely to be encountered in aircraft. And it's especially adaptable to jobs where space as well as weight is at a premium. It's about wrist watch size in length and width—and not a great deal thicker.

SERIES 345 RELAY. A radio relay for use in aircraft. Maximum contact combination of three pole, double throw, combined with large coil winding area makes this a highly efficient relay in compact space.

While thinking, building and engineering the tools of war today, Guardian is also looking ahead to peacetime applications of Relays, Solenoids, Electrical Controls of all kinds. If you are planning for the future too, write us—our war-time experience can help you build better peacetime products.



Series 195 Relay. One of the smallest relays made. Write for new Bulletin.



Series 345 Relay. For radio aircraft use. Write for new Bulletin.

GUARDIAN ELECTRIC

605 WEST WALNUT STREET CHICAGO, ILLINOIS

A COMPLETE LINE OF RELAYS SERVING AMERICAN WAR INDUSTRY

RADIO

★ DECEMBER, 1942

27



THERMADOR
THERMATITE TREATED
TRANSFORMERS
 Defeat humidity and
 Extreme heat problems



Aviation Audio Transformer
 (Thermatite treated)

THERMADOR transform-
 ers are "THERMATITE"
 treated. THERMATITE is a

process of accurate heat controlled vacuum im-
 pregnation, using the best grade of materials.

This process has been developed and improved
 by ten years of daily use by the same personnel
 and supervision.

THERMATITE impregnated transformers will
 therefore stand extreme conditions of climatic
 change. This is very important with their wide
 use all over the world.

EXPERIENCED ENGINEERS AT YOUR SERVICE

May we be of assistance in engineering and
 producing transformers to meet your specific
 requirements?

THE THERMADOR TRANSFORMER LINE

Included in the Thermador Transformer line are
 audio, auto, geophysical, bias supply, bridging,
 cathode modulation, coupling, driver, field sup-
 ply, filament, high fidelity audio, input, midget
 plug-in audio, mixing and matching, modulation,
 output, plate, power (combined plate and
 filament), television, and tube-to-line transfor-
 mers. Also manufactured are filters, chokes, and
 reactors (audio and equalizing).

"SEVEN LEAGUES AHEAD"



THERMADOR
THERMATITE TREATED
TRANSFORMERS

THERMADOR ELECTRICAL MANUFACTURING CO.
 5119 S. Riverside Drive, Los Angeles, Calif.

REPRESENTATIVES - Les Logan, 530 Gough St., San Fran-
 cisco, Calif. • Verner O. Jensen, 2607 Second Avenue, Seattle,
 Washington • M. J. Klicpera, P.O. Box 3113, Houston, Texas.

- Remote Control of Michigan Central, *Signaling*, Vol. 31, 1938, page 292.
- New Demand Metering Scheme for Extreme Accuracy—R. M. Schafer and M. H. Erdmann—*Electric Journal*, Vol. 35, 1938, page 381.
- Remote Control of Flat Rate Water Heaters in Toronto—C. W. Schwenger—*Electrical News*, Vol. 47, September 1, 1938, page 22.
- Phototubes Applied as Traffic Safety Aid—R. M. Sherman—*Electronics*, November, 1938.
- Remote Control Using 313-A (WE) OA4G (RCA) tube.—W. W. Shrage—*Radio Craft*, April, 1938.
- Siemens-Fernmessanlagen, *Archiv fur Technisches Messen*, No. 82, 1938, page 384.
- Midget Remote Amplifier Used at KCMO—L. C. Sigmon—*Electronics*, Vol. 11, January, 1938, page 38.
- Application and Performance of Carrier-current Relaying—P. Spron and C. A. Muller—*Journal AIEE*, Vol. 57, 1938, page 118.
- Street Lighting Control, *Electrician*, Vol. 121, 1938, page 577.
- Superimposed Control on L. T. Networks, *Electrical Times*, Vol. 93, 1938, page 305.
- Time Tuning, *Service*, December, 1938.
- Transkommando System, *A.E.G. Mitteilungen*, 1938, page 116.
- Remote control system for operating street lighting, sirens, etc.
- Les Developments Recents Dans la Commande a Distance et la Controle Automatique des Centralies et Sous-stations—N. Vadja—*Societe Belge des Electriciens*, Bull., Vol. 54, 1938, page 66.
- Remote Control Devices on the A.E.G. Selector System—W. Venzke—*A.E.G. Mitteilungen*, 1938, page 459.
- Hydraulically Operated Remote Controls—A. M. Washbauer—*Machinery* (N. Y.), Vol. 45, 1938, page 250.
- Remote Control Operation of Pressure Equalizing Stations at Oklahoma City—A. E. Watjen—*Water Works-Sewerage*, Vol. 85, 1938, page 535.
- Begin Remote Control by Use of OA4G Tube with Phased 60 Cycle AC and Carriers of Different Frequencies—W. N. Weeden—*Wireless World*, February 17, 1938.
- Selbsttatige Regelung von Temperaturen, Feuchtigkeit und Druck durch Elektrische Fernsteuergerate—P. Weber—*Zeitschrift fur Fernseldtechnik*, Vol. 19, 1938, page 8.
- Automatic regulation of temperature, humidity, and pressure, by electric remote control.
- Neue Schaltungen zur Fernsteuerung elektrischer, Strassenbeleuchtungsanlagen—K. Weisslass—*Association Suisse des Electriciens*, Bull., Vol. 29, 1938, page 618.
- Die Fernuberwachung bedienungs loser Gleichrichterwerke—H. Witte—*Elektrizitatswirtschaft*, Vol. 37, 1938, page 322.
- Remote control of automatic rectifier stations.
- System of Electric Remote-Control Accounting—L. F. Woodruff—*Journal AIEE*, Vol. 57, 1938, page 78.
- Actadis Ripple Control, *Electrical Times*, Vol. 92, 1937, page 819; *Electrical Review*, 1937, page 850.
- Describes equipment at Maidstone Corp. Electricity Works for remote control of street lighting.
- Electric Thermal Storage—F. J. C. Allen and W. C. Parker—*Steam Engineer*, Vol. 6, 1937, page 451; *Fuel Economist*, Vol. 12, 1937, page 365.
- Discusses remote control schemes.
- Automatic Remote Control for Oil Engines, *Oil Engine*, Vol. 5, 1937, page 184.
- Das Impulszeit-Fernmessverfahren—L. Brandenburger—*Archiv fur Technisches Messen*, No. 68, 1937, page T-19.
- Time impulse system of transmitting measurements.
- Wired Radio Control of Off-peak Heating of Electric Galvanizing Kettles—E. M. Bryson and A. M. Trogner—*Electrical World*, Vol. 107, January 30, 1937, page 42.
- Redeutung und Verbrichtung der Alkali-Hotozelle in Lichtgesteuerten Anlagen H. Briebrecher—*Elektrotechnische Zeitschrift*, Vol. 58, 1937, page 1351.
- Importance and use of alkali photo-cells in remote control.
- Le developpement des telecommunications par ondes portenses dans les grands reseaux interconnectes—F. Cahen—*International Conference on Large H. T. Systems*, Paris, Paper No. 336, 1937, 18 pages.
- Carrier-current communication in large networks.
- Vergleich zwischen Fernmessanlagen fur Gleich- und Wechselstrom—H. Dallman—*Elektrotechnische Zeitschrift*, Vol. 58, 1937, page 432.
- Comparison between d.c. and a.c. methods of transmitting measurements.
- Les Fontains Lumineuses a L'exposition de Paris—P. Demany—*Revue Universalle des Mines*, Vol. 13, 1937, page 532.
- Distant Control of Alarms and Street Lighting, *A.E.G. Mitteilungen*, 1937, page 331.
- "Synchronism Without Mechanical Connection"—C. W. Drake—*Electrical World*, Vol. 107, February, 1937, page 44.
- Interconnection of two wound-rotor induction motors to maintain synchronism for metering, etc.
- Fernubertragung und Zentralisierung der Messung von leitend und Arbeit bei der Italizischen Staatsbahn, *Siemens Zeitschrift*, Vol. 17, 1937, page 550.
- Transmission and centralization of power and energy measurements on the Italian state railway.
- Fernzahlwerke mit Voreinstellung fur Flussigkeitsmengen, *Archiv fur Technisches Messen*, No. 67, 1937, page F-2.
- Description of remote metering mechanism for flow meters with prearranged maximum indication.
- Zeitgemasse und Awickentasprachende Anforderungen an Fernmessanlagen *Verband Deutscher Elektrotechniker, Fachberichte*, Vol. 9, 1937, page 170, Disc. 172.
- Modern and appropriate requirements in tele-metering equipment. Power system and special purpose remote indication.
- Ford Centralized Control of New Gas Distribution Piping, *Heating, Piping & Air Conditioning*, Vol. 9, 1937, page 411.
- Compensating Method of Telemetering—N. F. Garkusha and Kornilov—*Izvdstiya Electro - Promyslennosti Sloboro Toka*, January 1937, page 23. In Russian.
- Einfache Schalter-Überwachungsanlagen mit Wahlerrelaid—W. Henning—*Siemens Zeitschrift*, Vol. 17, 1937, page 521.
- Simple switch-supervisory installations with selector relays.
- Distance Control of Street Lighting—T. F. Hildebrand—*Electrical World*, Vol. 108, November 6, 1937, page 61.
- Fernmess-Verfahren—A. Iliovici—*Archiv fur Technisches Messen*, No. 76, 1937, page T-132.
- Remote measuring methods. Frequency impulse system and variable frequency system.
- Verbindungen und Anwendungsmöglichkeiten der "Transkommando" Fernschaltung in Drehstrommetzen—Jacob and O. Hely—*Elektrizitats-Wirtschaft*, Vol. 36, 1937, page 398.
- Prerequisites and possibilities of application of Trans-Kommando remote control in three-phase network systems.
- Das Zusammenwirken von Fernbedienungs- und Selbststacurenlagen—J. Jager—*Verband Deutscher Elektrotechniker, Fachberichte*, Vol. 9, 1937, page 166, Disc. p. 169.
- Joint operation of remote control and automatic installations.
- Über die Reglung von Grossgleichrichtern mit Rohenreglern—H. Jungmichl, and Kottenhahn—*Siemens Zeitschrift*, Vol. 17, 1937, page 49.
- Control of high powered rectifiers with vacuum tube controller.
- A.S.E.A. Supervisory System on the Southern Railway—C. Kiessling and H. Ahlen—*A.S.E.A. Journal*, Vol. 14, 1937, page 174.
- Theorie der ausschlagsabhängigen Schnittregelung—M. Lang—*Zeitschrift fur Technische Physik*, Vol. 18, 1937, page 318.
- Theory of automatic step-by-step electrical control dependent on reflection: stability condition leading to design and adjustment of regulator.
- Lockheed Hydraulic Remote Controls, *Machinery*, Vol. 51, 1937, page 202.

Mechanische und Elektrische Wasserstand-Fernanzeiger — H. Lohmann — *Archiv fur Technisches Messen*, No. 67, 1937, page T-12.

Comparison of mechanical and electric remote water level indicators.

Utilisation des Liaisons Telephoniques et de Signalisation dans la protection selective des grands reseaux d'interconnection — S. Margoulies — *International Conference on Large H. T. Systems*, Paris, Paper No. 303, 1937, page 14.

Telephone and signalling lines in selective protection.

Die Schaltungstechnischen Verriegelungen von Schaltenlagen im Zusammenhang mit deren Fernsteuerung von einer Netzwerke — G. Meiners — *Zeitschrift fur Fernmeldetechnik*, Vol. 18, 1937, page 105.

Remote control of a network.

Von der Kraftwerkwerke zu Netzwerke — G. Meiners — *Elektrotechnik und Maschinenbau*, Vol. 55, 1937, page 61.

Power system control.

Pneumatic Telemetering—C. B. Moore — *Instruments*, Vol. 10, 1937, page 242.

Transmissione a distance, etc. — G. Musso — *Electrotecnica*, Vol. 24, 1937, page 6.

Remote Indication of Meter Reading—C. Myers—*G.E.C. Journal*, Vol. 8, 1937, page 201.

Control Rooms and Control Equipment of Grid System—J. D. Peattie—*Journal IEE*, Vol. 81, 1937, page 607.

Intermittent Multiple Transmission of Measurements—P. M. Pflieger—*A.T.M.* No. 67, January, 1937, page T9; *S.A.B.*, 1937, page 959.

Remote indicating multiple recorder for a number of channels.

Limitation of Transmission Distance for Measurements by Ordinary Instruments—P. M. Pflieger—*Archiv fur Technisches Messen*, No. 72, June, 1937, page T71.

Abstapweise Vielfachubertragung mit dem Impulsfrequenz — Verfahren — P. M. Pflieger — *Archiv fur Technisches Messen*, No. 67, 1937, page T9.

Principles and Practice of Automatic Control, *Engineer*, Vol. 163, January, 1937, page 94; *S.A.B.*, 1937, page 1679.

Description and theory of follow-up system.

Progres Recents et Applications des Equipements Automatque et de Telecommande a Contacteurs, *Rechnique Moderne*, Vol. 29, 1937, page 192.

Review of recent progress and applications of automatic equipment for remote control with aid of contactors.

Un example d'installations d'action a distance—A. Pux—*Electricite*, Vol. 21, 1937, page 195.

Remote Control and Telemetering, *Bulletin Cerliken*, No. 189-90, 1937, page 999.

Remote Control for Coal-Face Machinery, *Engineer*, Vol. 164, 1937, page 548; *Colliery Guardian*, Vol. 166, 1937, page 896.

Remote Control for Oil Engines, *Oil Engine*, Vol. 5, May, 1937, page 13.

Remote Control on "Pennsylvania," *Railway Age*, Vol. 102, 1937, page 383; *Railway Signalling*, Vol. 29, 1936, page 359.

Remote Control Switch Expedites Trains at Junction on Union Pacific, *Railway Signalling*, Vol. 30, 1937, page 565.

Operation of Apparatus by Remote Control Employing Multiplex Radio-Frequency Carrier Currents — H. W. Richards—N. Y., 1937, 47 pages.

Remote Supervisory Control and Remote Control of Haulages — H. W. Richards—*Mining Electrical Engineer*, Vol. 17, 1937, page 275.

Die Hochfrequenz-Fernmessenanlage eines Ausgedehnten Hochspannungnetzes — K. Riedel — *Siemens Zeitschrift*, Vol. 17, 1937, page 12.

High-frequency remote measuring installation on a large high-voltage network.

Mehrfachsusnutzung von Hochfrequenzkanalen fur Fernsprach — und Fernwerkanlagen — K. Riedel — *Verband Deutscher Elektrotechniker*, fachberichte, Vol. 9, 1937, page 174.

Multiple utilization of h.f. channels for telephony and remote control.

Schigyo-Iezne and Hicki-Takashi Power Line Carrier Telemeter, *Schibaura Review*, Vol. 16, 1937, page 139 (in Japanese).

Die Auswirkungen der Selektivschutz- und der Fernbedienungstechnik auf die Netzgestaltung—M. Schleicher—*Elektrotechnische Zeitschrift*, Vol. 58, 1937, page 235.

Interconnection of two wound-rotor induction motors to maintain synchronism for metering, etc.

Laws of Direct Regulation on a General Basis—K. Schmidt—*V.D.I.*, Vol. 81, 1937, page 1425; *S.A.B.*, Vol. 435, 1938.

Theory and criteria for selection of automatic control systems.

Selective Relay Method for Remote Control of Substations. *A.E.G. Mitteilungen*, 1937, page 450.

Fernbedienungsanlage fur das Umpannwerk Graffenstaden des EW Strassburg — W. Semmler — *Siemens Zeitschrift*, Vol. 17, page 28.

Remote Control—G. D. Smith—*Mining Electrical Engineer*, Vol. 17, 1937, page 408.

Electrical, mechanical, hydraulic and pneumatic systems of remote control discussed.

Telewatt Metering System, *Engineer*, Vol. 163, 1937, page 314.

Telephone and Signalling Lines in Selecting Protection, *International Con-*

ference on H.T. Systems—Pans. Paper No. 303, (14 pages), 1937, (Br.Fr.)

Gerate und Verfahren der Fernbedienungstechnik—W. Venzke — *Zeitschrift fur Fernmeldetechnik*, Vol. 18, page 189, 1937.

Apparatus and methods for remote control.

Remote Control by Selector System—W. Zenzke—*AEG Progress*, No. 2, 1937, page 30.

Control is Simplified with Hydraulics —A. M. Wasbauer—*Machine Design*, Vol. 9, June, 1937, page 37.

Syllabus of Telemetering Applications —L. D. White—*General Electric Review, Genie Civil*, Vol. 111, May, 1937, page 556, (In French).

Photo-electric Street Lighting Control —K. L. Yerger—*Electrical News*, Vol. 46, December 15, 1937, page 36.

Eine Interessante Fernmessenanlage fur die Lastverteilerstelle des EW Toho Denryoku, Japan—Bansen und K. H. Padszeck — *Siemens Zeitschrift*, Vol. 16, 1936, page 484.

Telemetering of the EW Tono Denryoku, Japan.

Kapazitive und Induktive Fernabstimmung mit Hilfe Abgeschirmter Kabel—H. Boucke—*Funk*, 1936, heft 9, page 269.

Les pannes d'Electricite Faincues par la signalisation et la commande a distance — P. de Bremecker — *Societe Belge des Electriciens*, Bul., Vol. 52, 1936, page 17.

Remote control and signalling on distribution systems.

Remote Control of Power Networks—G. A. Burns and T. R. Rayner—*Journal IEE*, Vol. 79, 1936, page 95.

C. & O. Installs Remote Interlocking, *Railway Age*, Vol. 100, 1936, page 363; *Railway Signalling*, Vol. 29, 1936, page 123.

Carrier-current Communication in Large Networks—F. Cahen—*International Conference on Large H.T. Systems*, Paris (In French).

Four M.G.D. Pumping Stations Remotely Operated — S. A. Canarits — *Water Works Engineering*, Vol. 89, 1936, page 26.

Telemetering Application and Operations—L. D. Carlyon—*Power*, Vol. 80, 1936, page 22.

Development of Supervisory Control Systems, *Nippon Electrical Communication*, 1936, page 275.

Supervisory Control and Remote Metering—J. V. B. Duer—*Electrical Engineering*, Vol. 55, 1936, page 70.

L'Installation de Telecommande sans fil Pilote de la Zone a Courant Continua Troils Fils de la Compagnie Parisienne de Distribution d'Electricite—

[Continued on page 32]

Meissner
IS HONORED
BY AN AWARD

ARMY **E** NAVY

for **HIGH ACHIEVEMENT
IN WAR PRODUCTION**

Meissner is deeply grateful for this honor bestowed upon our employees, made possible by their sincere cooperation and unswerving loyalty to duty.

This Army-Navy "E" award will be an inspiration to the entire Meissner organization to put forth increased efforts to win the battle of production.

Meissner
MT. CARMEL, ILLINOIS
"PRECISION-BUILT PRODUCTS"



Meissner employees are justifiably proud of their "E" emblems... the symbol of a job well done.

- M. Duepaire, and A. Perlat — *Revue Generale de l'Electricite*, Vol. 40, 1936, page 149.
Remote control without pilot wires in Paris.
- Die Olschalter-Fernmeldeeinrichtung der Steirischen Wasserkraft und Elektrizitat A.G.—H. Eigl—*Elektrotechnik und Maschinenbau*, Vol. 54, 1936, page 509.
Remote control of oil switches.
- Fernsteuer- und Überwachungs-Anlagen für Kleine Unterwerke. *Zeitschrift für Fernmeldetechnik*, Vol. 17, 1936, page 151.
Remote control and supervisory arrangements for small substations.
- Technics of Measurements at a Distance — N. F. Garkusha — *Investiya Elektro-Promishlennosti Slabovo Toka*, No. 2, 1936, page 33.
- Neue Elektrische Übertragungs- und Zahleinrichtung für Durchflussmesser — W. Geyger — *Archiv für Elektrotechnik*, Vol. 30, 1936, page 240.
Electrical remote recording of flow meters.
- De la teledindication a le telecommande — Granat — *Societe Belge des Electriciens, Bull.*, Vol. 52, 1936, page 1.
Remote indications and remote control.
- Field Trail of 50-Cycle Signalling on Toll Lines — W. Hatton — *Electrical Communication*, Vol. 15, October, 1936, page 107.
- Perfectionnements dans les dispositifs de telemesure — A. Iliovici — *Societe Francais des Electriciens, Bull.*, Vol. 6, 1936, page 826.
Improvement in remote measurements.
- Fernsteuer- und Überwachungs-Anlagen für Kleine Unterwerke — Klee- mann — *Zeitschrift für Fernmeldetechnik*, Vol. 17, 1936, page 151.
Remote control and supervisory equipment for small private branch exchanges.
- Die Wasserstand-Fernmess-, Fernsteuer- und Fernsprechanlage für das Stadtische Wasserwerk Schwarzbach A.D.S. 1936—W. Knapp—*Siemens-Zeitschrift*, Vol. 16, 1936, page 119.
Control and communication system of the Schwarzenbach Water-works.
- Les Relais a Resonance Mechanique et Les Telecommandes Sans Fil Pilote—M. Lavet—*Societe Francais des Electriciens, Bull.*, Series 5, Vol. 6, 1936, page 81.
Relays with mechanical resonance and distance control without pilot wire.
- Pressure Telemetry and Remote Control — W. A. LaVillette — *Pacific Coast Gas Assn., Proc.*, Vol. 27, 1936, page 92.
- Dispositif Permettant la Connection Automatique des Relais de Coupure a Distance des Circuits des Guerities — M. Lefevre — *Annales des Postes, Telegraphes et Telephones*, Vol. 25, 1936.
Automatic remote control of cut-off relays at testing points.
- Le Misura a Distanza Facilitatrici dell'esercizio—W. P. Leonhardt—*Politecnico*, Vol. 84, 1936, page 130.
Review of European systems of remote control and remote measurement apparatus in power plants, water works, etc.
- Remote Metering and Automatic Load Control—J. T. Logan—*Journal AIEE*, Vol. 55, 1936, page 40.
- Metering by Carrier Current — J. G. McKinley—*Electrical Journal*, Vol. 33, 1936, page 411.
- Remote Metering on West Pennsylvania System—J. G. McKinley—*Electrical Journal*, Vol. 33, 1936, page 411.
- Die Elektrische Fernsteuerung der Doppelstockigen Stromlinienzüge der Lubeck-Buchener Eisenbahn—P. Mauck — *Elektrotechnische Zeitschrift*, Vol. 57, 1936, page 1023.
Electric remote control equipment of double-deck streamlined trains of Lubeck-Bechen RR.
- Remote Indication of Operation of Automatic-Reclosing Circuit Breakers—J. G. Park—*Electrical Times*, Vol. 89, 1936, page 151.
- Fernmessung nach dem Dual-Zahlen-Verfahren—P. M. Pflier — *Archiv für Technisches Messen*, Vol. 5, 1936, No. 58, page T46.
Remote measurements according to dual-number method.
- Gleichzeitige Vielfach-Fernmessung mit dem Impulsfrequenzverfahren—P. M. Pflier — *Archiv für Technisches Messen*, No. 62, 1936, page T105.
Simultaneous multiple remote measurements by impulse frequency method.
- Impulse-Frequency Remote-Control Measurements—P. M. Pflier — *Archiv für Technisches Messen*, January, 1936, Vol. 5, page T1.
- Impulskompensations - Fernmessverfahren—P. M. Pflier—*Archiv für Technisches Messen*, Vol. 5, No. 59, 1936, page T58.
Impulse compensation remote measuring methods.
- Stand Der Fernmessung—P. M. Pflier — *Verein Deutscher Ingenieure, Zeitschrift*, Vol. 80, 1936, page 1461.
Present position of telemetering.
- Photo-telemetry System, *Engineer*, Vol. 161, 1936, page 396.
- Brown Boveri Remote-Control System — O. Plechl — *Brown Boveri Review*, Vol. 23, 1936, page 179.
- Remote Control. Application of Electrical Equipment in Mines, *Electrician*, Vol. 117, July 10, 1936, page 42.
- Fernüberwachung und Fernsteuerung von Schaltern bedienter Betriebstellen — O. Plechl—*Elektrotechnik und Maschinenbau*, Vol. 54, 1936, page 421.
Remote control of switches.
- Remote Control for Mechanical Transmission, *Diesel Railway Traction*, October 30, 1936, page 730.
- Remote Control Involves Santa Fe and Rock Island, *Railway Signalling*, Vol. 29, 1936, page 247.
- Remote Control Replaces Mechanical Interlocking on Louisville and Nashville, *International Railway Congress Association Bulletin*, Vol. 18, 1936, page 979; *Railway Signalling*, Vol. 29, 1936, page 196.
- Installation de Telereglage des Usines Generatrices de la Societe de Electrochimie, l'Electrometallurgie et des Acieries Electriques d'Ugine—P. Salmon-Legagneur — *Revue Generale de l'Electricite*, Vol. 40, 1936, page 243.
Equipment and installation of remote control of a generating station.
- La Jonction Electrique "Siemens" a mouers Asynchrones Triphas. Etude Electromecanique—P. Satche — *Revue Generale de l'Electricite*, Vol. 40, 1936, page 595.
- Fundamentals of Teleprinter Operation—F. Schiweck—*T.F.T.*, 1936, page 25; *S.A.B.*, 1937.
Comprehensive study of Modern Teleprinter; bibliography.
- Ferngesteuerte Betriebskontrolle im Braunkohlen Bergbau—Schrock — *Braunkohle*, Vol. 35, 1936, page 634.
Remote control of operation in lignite mines.
- Selection of Supervisory System—W. P. Simpson — *Electrical World*, Vol. 106, March, 1936, page 42.
- Die Vielfachsteuerung von Triebwagen mit Antrieb durch Verbrennungsmotor — R. Spies—*Verkehrstechnik*, Vol. 17, 1936, page 261.
Multiple control of rail motor cars; details of system employing remote control.
- Neuzeitliche Elektrische Turmuhren—Springer — *Zeitschrift für Fernmeldetechnik*, Vol. 17, 1936, page 85.
Modern electric church tower clock, describes remote control by master clock.
- L. & M. Consolidates Interlocking—W. H. Stillwell—*Railway Signalling*, Vol. 29, 1936, page 353.
- Apparatus for Telemetry and Remote Indicating of Totalized Load—Tanisi-Seiti and Okada-Keizi — *Schaibaura Review*, Vol. 15, page 365, 1936. (In Japanese).
- Remote Control on "Frisco"—R. W. Troth — *Railway Signalling*, Vol. 29, 1936, page 76.
- Die Fernsteuereinrichtung für die Stromversorgung der Stadt Mailand—L. Volker — *Elektrotechnische Zeitschrift*, Vol. 57, 1936, page 33.
Remote control of the current supply to the city of Milan.
- Die Telenerganlage des Elektrizitätswerks Potsdam — Werner — *Siemens Zeitschrift*, Vol. 16, 1936, page 101.
- Yard Entrance in Montreal Remotely Controlled, *Railway Signalling*, Vol. 29, 1936, page 193.
- Telereglage de la Puissance et de la Frequence enas les Grands Reseaux a Haute Tension—L. Barbillion—*Houille Blanche*, Vol. 34, 1935, page 15.

[Continued on page 34]



This is a "GLOBAL" war... A man-made globe — the electronic tube — is today one of the key weapons of battle. Eimac tubes have assumed a rank of "high command" in this "global" war. Again they are "first choice in the important new developments in radio"

THE JOINT ARMY-NAVY "E" awarded September 4, 1942 ... first award of this kind to a manufacturer of electronic tubes.

EITEL - McCULLOUGH, INC.

SAN BRUNO, CALIFORNIA

Export Agents: Frazar & Company, Ltd., 301 Clay St., San Francisco, Calif.

Eimac
TUBES



- Telemetering and Totalizing—P. A. Borden and M. F. Behar—*Instruments*, Vol. 8, 1935, page 323.
- Ein Neuer Fernmess-Summengeber — L. Brandenburger — *Siemens Zeitschrift*, Vol. 15, 1935, page 511.
Distant-recording summator.
- Remote Metering Over Power Lines—L. Dalman—*A.S.E.A. Journal*, Vol. 12, 1935, page 158.
- Data Transmission and Remote-Control Sight System for Anti-Aircraft Machine Guns—L. A. Denson—*Coast Artillery Journal*, Vol. 78, 1935, page 279.
- Operating Mine Hoist by Remote Control—G. M. Dick — *Canadian Mining Journal*, Vol. 56, 1935, page 226.
- Telesommande sur Reseaux de Distribution d'Energie Electrique sans fil Pilots—J. Durepaire—*Societe Francais des Electriciens, Bul.*, Vol. 5, 1935, page 513.
Remote control without pilot wires.
- Fernubertragung von Messwerten mit Widerstands-Gebern; I and II — W. Geyger—*Archiv fur Technisches Messen*, Vol. 5, No. 53, 1935, page T148; Vol. 5, No. 54, page T160, 1936.
Telemetering with resisting transmission equipment.
- Induktive Fernubertragung von Bewegungsvorgängen—W. Geyger—*Archiv fur Technisches Messen*, Vol. 4, No. 46, 1935, page T49; Vol. 4, No. 48, 1935, page T76.
Inductive remote transmission of processes of motion.
- Gas Transmission Main Remote Pressure Recording System—B. R. Harvey—*Gas Age Record*, Vol. 75, 1935, page 378.
- Installation de Teleregage de Frequence et de Change Realisee Pour la Societe des Aciers d'Ugine—Henry-Lepaute—*Societe Francaise des Electriciens, Bull.*, Series 5, Vol. 5, 1935, page 65.
Remote control of frequency and load.
- Principles de la Surveillance a Distance des Reseaux Electriques—W. Howald—*Association Suisse des Electriciens, Bull.*, Vol. 26, 1935, page 477.
Remote supervision of electric networks.
- Small Steam Turbine Station Operates Entirely Unattended — X. D. Ides — *Power Plant Engineering*, Vol. 39, 1935, page 684.
- Die Fernmessanlage das Frankischen Oberlandwerks — A. F. Nurnberg, A. Kennelmeier and W. Semmler—*Elektrische Zeitschrift*, Vol. 56, 1935, page 235.
Remote measuring equipment of Frankischen Oberlandwerks, A.G., Nurnberg.
- Remote Control of a Laholm Power Station—C. Kiessling—*A.S.E.A. Journal*, Vol. 12, 1935, page 62.
- Centralization of Control of Power Networks — E. M. S. McWhirter — *Electrical Communication*, Vol. 13, 1935, page 255.
- Wasserstands-Fernanzeiger fur Dampfkessel—W. Marcard and H. Botzong—*Berein Deutscher Ingenieur, Zeit.*, Vol. 79, 1935, page 1397.
Remote water-level indicator for boilers in elevated position; illustrated description of design and characteristics of mechanical, hydrostatic, optical and electric types.
- New Departures in Remote Control, *Chemical Age* (London), February 16, 1935, Vol. 32, page 159.
Cope's Control Valve.
- Remote Supervisory Control of Switchgear—S. E. Newman, R. T. Lythall—*English Electric Journal*, Vol. 7, 1935, page 103.
- Practical Radio Communication*—A. R. Nixon—McGraw-Hill, 1935, page 383.
- Das Impulszahl Fernmesverfahren — P. M. Pflieger—*Archiv fur Technisches Messen*, Vol. 5, No. 54, page T162, 1935; Vol. 5, No. 55, page T1, 1935.
Remote measuring by impulse-counting.
- Die Fernmesverfahren—P. M. Pflieger—*Archiv fur Technisches Messen*, Vol. 5, No. 51, 1935, page T115.
Remote measuring methods.
- Summierung bei der Impulsfrequenz-Fernmessung—P. M. Pflieger — *Siemens Zeitschrift*, Vol. 15, 1935, page 457.
Summation in impulse frequency telemetering.
- Le commande a distance des circuits electriques—M. Poudade—*Electrician*, Vol. 66, 1935, page 27.
- Telemetering Aids Operation of District Steam Distribution System—T. E. Purcell—*Heating, Piping & Air Conditioning*, Vol. 7, 1935, page 465.
- Remote Control Switching (Patent), *Wireless Engineer*, Vol. 12, April, 1935.
- Remote Control on "Seaboard," *Railway Signalling*, Vol. 28, 1935, page 527.
- Remote Control on T. & N. C., *Railway Signalling*, Vol. 28, 1935, page 513.
- Remote-Reading Level Recorder, *Engineering*, Vol. 139, 1935, page 361.
- Fernmessanlagen in Ausgedehnten Landesnetzen — K. Riedel — *Verband Deutscher Elektrotechniker, Fachberichte*, 1935, page 160.
Remote measurements on long transmission lines.
- Telecontrôle et telecommande des sous-stations-Sauvaire—*Industrie des Voies Ferrées & des Transporte Automobile*, Vol. 29, 1935, page 180.
Remote control of sub-stations.
- Fernsteuerung über Wechselstromnetze — H. A. Schwab — *Verein Deutscher Ingenieur, Zeitschrift*, Vol. 79, 1935, page 63.
Remote control on a.c. networks.
- Automatic Telemetering and Supervisory Automatic—A. Trenner—*AEG Progress*, No. 2, 1935, page 21.
- Controllea commande a distance negli acquedotti—G. Veronese—*Annali del R. Istituto Superiore d'Ingegneria di Padova*, Supp. to No. 2, 1935, Vol. 4, page 209.
Remote control in operation of aqueducts.
- La Commande a Distance des Bifurcations et zones d'iguillages—Vinot—*Revue Generale des Chemins de Fer.*, Vol. 54, 1935, page 77.
Remote control of railroad branching and switching points.
- Thermionic Valve Telemetering—E. G. Watts—*Electronics*, Vol. 8, 1935, page 50.
- Telereglage et Telemesure—L. Barbillion—*Electricien*, Vol. 65, 1934, page 443.
Remote control and remote measurements.
- Remote Control for Compressors Having Pressure Governors — G. A. S. Cooper — *Gas Age-Record*, Vol. 74, 1934, page 361.
- Remote Control for Shaking Conveyors—A. R. Cooper—*Colliery Engineering*, Vol. 2, March, 1934, page 92.
- Untersuchung über den Zeitlichen Verlauf der Messgrosse und der Angezeigten Grosse bei den Gebrauchlichen Fernmesverfahren unter Bedonderes Berücksichtigung der Stetigen Übertragung — H. Dallmann — *Archiv fur Elektrotechnik*, Vol. 28, 1934, page 432.
Lag in indication of transmitter measurements.
- Distant Repeating Apparatus, *Power Engineer*, Vol. 29, 1934, page 64.
- Elektrische Fernuberwachung von Zeigerstellungen mit Ruckwirkungsfreien Wechselstrom-Ferngebern — W. Geyger — *Archiv fur Elektrotechnik*, Vol. 28, 1938, page 689.
Distant reproduction of meter readings.
- Selbsttatige Druck- und Temperaturberichterung bei der Messung Stromender Gas und Dampfmenngen mit Differenzdruckmessern und Wechselstromgespeisten Ohmmetrischen Anzeige-, Schrieb-, und Zahlgeraten—W. Geyger—*Archiv fur Elektrotechnische*, Vol. 28, 1934, page 57.
Remote flow meters.
- Automatic Street Traffic Signalling*—H. H. Harrison and T. P. Preist—London; Pitman, 1934, 187 pages.
- Electron Tubes in Industry*—K. Henney—McGraw-Hill, pages 141 and 218.
- Interconnected Power Systems—S. B. Jackson—*Electrical Review*, Vol. 114, 1934, page 551.
- Selbststeuerung und Fernbedienung im Betriebe von Wasserkraftanlagen — F. Jager — *Siemens Zeitschrift*, Vol. 14, 1934, page 299.
Automatic and remote control in operation of hydroelectric power stations.
- Junction on Santa Fe is Remotely Controlled, *Railway Signalling*, Vol. 27, 1934, page 21.

[To be continued]



RACONS do their bit—

★ Under prime and sub contracts RACON Products contribute to many phases of the war effort. For example, shown here is a RACON Marine Horn Speaker in the cabin of the B-19; and in the other extreme, on the ground a Sperry anti-aircraft detector battery, the three locator horn units of which were made by RACON.

★ If space permitted we'd show how RACONS are used at Army and Air Force training bases—at shipyards—aboard Navy, Coast Guard, Maritime Commission and Transport ships—in factories, and in countless industrial public-address systems.

★ The most important point is this, the quality, efficiency and dependability of RACONS have long been recognized. There's nothing finer. RACONS deliver more energy per watt input. They use RACON's exclusive Waterproof, Weatherproof, Acoustic Material. The elements cannot affect RACON's efficient operation. Use RACONS when planning your next installation. There is a horn, speaker or driving unit for every conceivable purpose. Inquiries are invited—perhaps we can help you in some phase of the war effort. Ask for our free catalog, too.

RACON ELECTRIC CO., 52 East 19th St., New York, N. Y.

RACON

RADIO

★ DECEMBER, 1942



Official Photos by
U. S. Signal Corps;
courtesy of Douglas Aircraft Co. and
Sperry Gyroscope Co.

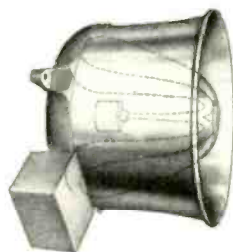

MARINE
HORN SPEAKERS



RACON P. M.
HORN UNITS

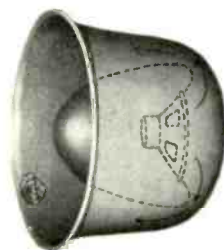

MARINE
CONE SPEAKERS

Shown here are but two of the many RACON Speakers and one type of RACON P. M. Horn Unit. The MARINE HORN SPEAKER may be used as a loud-speaker or microphone, comes in several sizes; is approved by the Bur. of Marine Inspection, Dep't. of Commerce. MARINE CONE SPEAKERS are the re-entrant type, suitable for indoor or outdoor use. Stormproofed for all weather conditions. Sizes for 2, 3, 5, 8 and 12 inch speakers. RACON P-M HORN UNITS are available in operating capacities of from 5 to 50 watts.



AK HIGH-SPEED

KEYING BREAK-IN RELAY

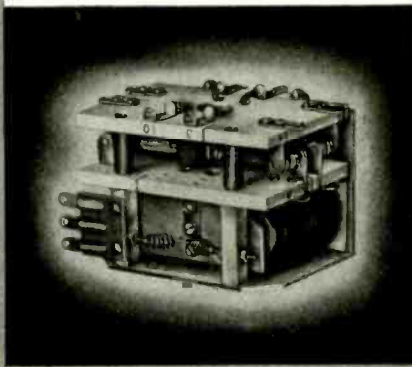
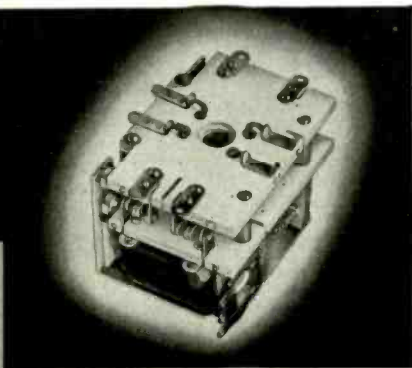

Completely balanced... arms equipped with anti-bounce features

Mounting features with elastic stop nuts

Magnetically held in both positions... does not rely on back spring pressure

Keys at 20 cycles per second

Insulation plates of high pressure Stealite

Wattage consumption 5.5 in first position 17.0 in second position

All terminals easily accessible

Contact rating 1,000 volts at 30,000 feet. 20 megacycles . . . 4 pole double throw

Withstands vibration to better than 20 G

Insulated to sustain 10,000 volts at sea level

Dimensions 2-7/16 x 3 1/2 x 2 1/4

● **AK** a compact, high voltage, high speed, anti-vibration type keying relay for break-in operation in aircraft radio equipment. A push-pull magnetic arrangement which provides magnetic holding pressure on both transmit and receive contacts. One pole is equipped with two windings, one of which is a holding winding connected directly across the battery supply. The other winding is connected in series with the single winding on the other pole and polarized so that when the circuit is completed through the key, the flux is neutralized on the holding or receive position pole and the armature pulls up to the transmit position. Opening the key cuts off the bucking flux and the holding flux pulls armature back to receive position.



227 FULTON ST., NEW YORK
Factories
NEW YORK CITY • LONG ISLAND CITY
CHICAGO • PLANTSVILLE, CONN.

Q. & A. STUDY GUIDE

[Continued from page 19]

that tube life is shortened when filaments are operated above normal voltages. If the filament voltage is below normal the life of the tube is increased but its efficiency decreased.

9. Why is it desirable to use an alternating-current filament supply for vacuum tubes? (II-154).

10. When an alternating-current filament supply is used, why is a filament center tap usually provided for the vacuum-tube plate and grid return circuits? (II-158).

11. Why should the cathode of an indirectly-heated type of vacuum tube be maintained at nearly the same potential as the heater circuit? (V-39).

12. Why is it advisable to periodically reverse the polarity of the filament potential of a high-power vacuum tube when a direct-current supply is used? (II-155).

When vacuum-tube filaments are operated from alternating current it is only necessary to use a step-down transformer. This eliminates the necessity for batteries and charging equipment and high-current d-c generators in the case of large transmitting tubes.

From Fig. 1-A it is apparent that there is an alternating potential drop across the filament when an a-c supply is used. This will cause the plate-filament potential to vary and hence there will be a corresponding variation in the plate current, frequently referred to as hum. The hum may be reduced considerably by returning the plate and grid circuits to the electrical center of the filament. Fig. 1-A and B, illustrate how this is accomplished by using either a center-tap transformer or resistor. The condensers are used to bypass the high-frequency currents around the transformer secondary.

In the case of indirectly-heated cathodes, as in Fig. 1-C, there is no potential drop along the emitter. Hence, it is known as a uni-potential cathode. There should be no potential difference between the cathode and the heater. This will prevent leakage, which might result from a breakdown of the refractory insulating material.

High-power transmitting tubes generally use a direct-current filament supply. Fig. 1-D indicates that the plate current will flow along one side of the filament since the plate circuit return is to one side of the filament. If the polarity is left the same for any length of time, there will be a greater thinning of one side, resulting in shortened filament life. Reversing filament-

[Continued on page 39]



*"Still Doing Business
at the Same Old Stands"*



SERVICEMEN

... your Distributor can
STILL Supply you with

Centralab

MIDGET RADIOHM REPLACEMENTS

Fortunately . . . your distributor
can still supply you with Midget
Radiohms for replacements.

The smooth wall-type resistor for
which Centralab Radiohms are
famous will keep that now-precious
radio in good working condition.

Stick to OLD MAN CENTRALAB
for Replacements . . . and always
specify "CENTRALAB".

- RADIOHMS • FIXED RESISTORS
- FIXED AND VARIABLE
CERAMIC CAPACITORS
- SELECTOR SWITCHES

CENTRALAB: Div. of Globe-Union Inc., Milwaukee, Wis.

*Radio's outstanding practical text...
...for war-training and regular purposes*

RADIO Handbook

NINTH EDITION

The new ninth edition is now ready

Revisions in this edition adapt it even better than ever before for war-training and general use; contains added and simplified theory in the simplest possible language; added test equipment which can be home- or field-constructed; and a review of mathematics for solving simple radio problems.

More than 600 pages; durably clothbound; goldstamped. Get it from your favorite dealer, or direct from us, postpaid; please add any applicable taxes.

\$2.00 in continental U. S. A.

Elsewhere, \$2.25

Published by

Editors and Engineers, 1422 North Highland Avenue, Los Angeles

To the trade: Radio parts stores, schools, and governmental units may order direct from us; all other trade outlets should order through the nearest branch of the American News Co., Inc.

[Continued from page 36]

supply polarity each week will result in uniform aging of the entire filament.

13. What is indicated when a blue glow is noticed within a vacuum-tube envelope? (V-44).

14. What is meant by a "soft" tube? (II-121).

15. What are the visible indications of a soft tube? (II-125).

If gas is present in a high-vacuum tube, ionization may take place. Each gas molecule is broken down into a positively-charged ion and one or more negatively-charged ions or electrons. The latter will cause a greatly increased plate current; enough, sometimes, to cause the plate to be excessively reddened. The ionized gas will also cause a blue glow to appear between the cathode and plate. These phenomena are indications of a "soft" tube.

THIS MONTH

[Continued from page 24]

and by applying certain patterns of distortion lying only within the middle range of audio frequencies, it is possible to simulate low and high frequency sensations; this, despite the absence of low and high frequency signals in the sound conveyed to the ear.

One of the many applications of the development is the reproduction of an apparently hi-fidelity signal from a receiver having a poor bass and high frequency response.

[Continued on page 40]



NEW POLICE RADIO EQUIPMENT

New mobile FM police radio equipment developed by General Electric electronic engineers, and being manufactured for the "radio reserve pool" established by WPB, incorporates many new features, some of them suggested by police users in many parts of the country. This is revealed in an announcement by D. L. Chesnut, of the G. E. Radio, Television and Electronics Department at Schenectady, N. Y.



THE PRODUCT MAY CHANGE

Behind the cloak of wartime secrecy, the best radio and electronic engineers in the world are perfecting the devices that will shorten this war. Theirs is the equipment that will help purge civilization of the infection that is Schickleguber and Company.

The preference of free America's radio engineers, jobbers and amateurs for JOHNSON products has made possible the modern JOHNSON plant and personnel that is today doubling and tripling its production of the kind of parts that will speed our victory. War's tremendous impetus will mean new and improved JOHNSON products for tomorrow's peace, but the Viking Head trade mark and JOHNSON'S leadership in quality and design which it symbolizes will not be altered.

JOHNSON

a famous name in Radio

VICTORY PARTS

The American Standards Association is starting "Victory" repair standardization at the request of OPA and the War Production Board.

As soon as the committee has completed its work of standardizing the myriads of parts used in home radio receivers, the WPB and OPA are ex-



Buy with Confidence

Regardless of quality, products of unknown origin have two strikes on them. They give the user a feeling of mental insecurity. He lacks confidence in them.

The unknown-brand manufacturer often has no incentive beyond building a product that will sell, usually at a price. On the other hand, to the maker of nationally known products, the sale of his product merely marks the beginning of an obligation, the need to see that the customer is satisfied.

Quality merchandise, honest advertising, fair-trade practices, a keen awareness of obligation to the customer, and friendly help in application-problems are earmarks of the reliable radio-parts manufacturer. You can count on Mallory.

P. R. MALLORY & CO., Inc.
INDIANAPOLIS INDIANA
Cable Address — PELMALLO



pected to allot materials for manufacture of the standardized replacement parts and to issue limitation and price orders. The ASA standards will thus serve as a basis for assurance of continued operation of all modern home receivers for the duration of the war.

Considerable care is being exercised by the ASA committee to make sure that the quality of the standard repair parts chosen will be suitable from the set owners' standpoint. The "Victory" line of repair parts will be fully defined as to performance, dimensions and construction in the standards now in preparation. Sufficient parts of each type will be included in the standards to adequately service almost all of the modern home receivers in use today. Tubes are not included in the project.

In the design of these standard parts the ASA War Committee is making every effort to provide units that will be mechanically interchangeable with present parts with a minimum of difficulty. In addition, non-critical or less critical materials, and less of these materials, will be used wherever possible in these parts as compared to their peacetime prototypes.

Through simplification of the number of varied ranges now in use and the use of multi-purpose units when practicable, the actual number of parts will be held to an absolute minimum in the forthcoming standards. This will further serve to reduce the amount of strategic materials kept in inventory by minimizing the stock of parts held by jobbers and service men.

For example some 62 standard volume controls have been proposed to serve as replacements for the overwhelming majority of the thousands of different types used in home radio sets built during the past half dozen years while 9 electrolytic and 11 paper capacitors have been proposed to do a similar job in the capacitor field. Similar simplification and standardization in other radio parts such as transformers, chokes, coils, resistors, etc., is also included in the scope of the project now getting under way.

The War Production Board will maintain very close contact with the standardization work through its liaison representatives on the ASA committee and through its WPB Radio

Parts Industry Advisory Committee which is furnishing draft specifications and simplified parts lists to the ASA Committee for review and revision. Following consideration by the ASA Committee, the proposed standards will be circulated through various radio set manufacturers, design laboratories, service organizations, and others concerned for comment. After review of the comments, desirable revisions in the standards will be made by the ASA Committee before the standards are officially promulgated.

★

THE CONTROLLED MATERIALS PLAN

The Controlled Materials Plan—CMP—is becoming a new way of life for the majority of United States manufacturers. It is important to the war effort and to industry that everyone using the basic and critical materials, steel, copper and aluminum, understand CMP as it applies to his operations.

The Controlled Materials Plan gets its name from the control which is applied to the three metals, steel, copper and aluminum, which are specifically allocated under its terms. It is believed that if production is controlled in terms of these three metals the distribution of other metals will be relatively simple. It may develop that some other materials will have to be brought under similar control. But of the materials widely used for production, steel, copper, and aluminum are believed, at the present time, to show the greatest shortage relative to demand.

Control of material, however, is really only one-half of the job undertaken by the new plan. The other, and perhaps more important half, might be called "Controlled Schedules." Schedules are to be limited to the material available as a condition of the allotment; thus, schedules will be controlled not only on the basis of what is wanted, as heretofore, but also in terms of what can be realized from the raw materials available.

The Controlled Materials Plan ties together the control of material and the control of schedules through the simple procedure of making raw material allotments through the same channels followed in setting the production schedules. For example, the Army sets the production schedules for the prime contractors for tanks; under CMP the Army will also allot the material to the prime contractor of tanks, who in turn will re-allot it to his sub-contractors, also setting production schedules for his sub-contractors. If it becomes necessary to cut the amount of material available for the production of tanks, the Army will reduce the production schedules of the prime contractor, and at the same time, reduce

[Continued on page 42]



In the radio field it's **RADIO**

The editorial contents are devoted strictly to radio design, engineering, production and operation. The "Bibliographies", "Design Worksheets", and data on the theory and application of radio devices **published exclusively in RADIO**, are helpful to every engineer and technician engaged in all phases of civilian and military radio work. **Subscribe today! Offer expires February 1st.**

15 Big Issues-\$3.00 regular price is \$3.00 for 12 issues

27 Big Issues-\$5.00 regular price is \$5.00 for 24 issues

Special: Subscription price to men in the armed service \$1.50 per year

TEAR OUT AND MAIL-----Use the Coupon Below-----TEAR OUT AND MAIL

It must be filled-in completely.

"RADIO"
Radio Magazines, Inc.
132 W. 43rd St., New York City

SPECIAL MONEY-SAVING OFFER
15 issues \$3.00—27 issues \$5.00

SIRS: Please send me the next issues of RADIO. Here is my check (or money order) for \$
(Remit by Check or Money Order. We cannot assume responsibility for cash sent thru mails)

Name (print carefully)

Address City State

Name of Firm You Work For

Title or Position You Hold (please be explicit)

[Continued on page 40]

the amount of the material to be made available. The prime contractor will go through the same steps with his subcontractor.

This process, called "vertical allocation," differs from the previous system in that, under PRP, the War Production Board issued the authorizations to the manufacturers as to the amount of material they were permitted to procure, while the Army, Navy and other Agencies issued instructions as to the production schedules to be maintained. It was often not possible to insure co-

ordination, and the manufacturer was faced with a conflict between production schedules and material authorizations which he could not resolve.

Mr. John L. McParland, of WPB, explained the new system to members of the Western Sales Managers Club, at their meeting on Tuesday, December 2nd, in Chicago. Mr. J. J. Kahn, of Stancor, presided.

★
**KFAR, ALASKA, OPENS AS
5,000 WATTER**

Reopening of Station KFAR at Fairbanks, Alaska, has established a

new American broadcasting frontier for radio programs at a point close to the top of the world. KFAR has been stepped up from 1000 to 5000 watts by permission of the Federal Communications Commission, and equipped with twice that power for use after the war as an RCA type 10-DX, 10-KW Transmitter.

★
The Raytheon Replacement Sales Department has been transferred from the New York office to the factory at 55 Chapel Street, Newton, Massachusetts. Future correspondence should therefore be addressed to the factory.

★
INSULINE EXPANDS

In a new expansion move, The Insuline Corporation of America has acquired a large modern factory building in the heart of Long Island City.

Catalogues describing the complete line of Insuline products may be had by writing to the new address: Insuline Corporation of America, The Insuline Building, 36-02 35th Avenue, Long Island City, N. Y.

★
EICOR EXPANDS

Eicor, Inc., manufacturers of Dynamotors, D.C. Motors, Converters, Power Plants, and other rotary electrical apparatus, have moved to a new DPC building at 1501 W. Congress St., corner of Congress and Laffin, Chicago. This move will provide considerably more factory space and production facilities to meet the tremendously increased need for Eicor Products in the war program.

★
R.C.P. CUSTOMERS' SERVICE

Irving Berkman has been appointed manager of priorities and expediting for the Radio City Products Co., Inc., New York City, manufacturers of electrical and electronic test instruments.

The addition of Mr. Berkman to the staff will enable the company to be of greater service to its customers and the various government agencies in expediting orders and production.

★
DR. POWER JOINS SIGNAL CORPS

Dr. Ralph L. Power, advertising manager of the Universal Microphone Co., Inglewood, Cal., who served overseas as a warrant officer during World War I, has become an inspector in the U. S. Army Signal Corps with assignment from the San Francisco zone area to a field unit in Southern California.

Mrs. D. H. Cameron, for the past ten years office secretary at the Power Agency in Los Angeles, has taken over the business.

Morse M. Peterman, assistant man-



★
**LET'S ALL
PITCH IN!**

WE CAN all help win this war by selling our government the communication receivers and transmitters they need quickly and in sufficient quantities.

That is the reason we are paying *highest cash prices* for used communications equipment.

When this war for the "four freedoms" is over you will undoubtedly be in the market for new equipment and by taking advantage of our offer to purchase your present equipment at highest cash prices you will be in a position to buy a new and better receiver than you now own.

Write, telephone or telegraph us description of your used communications receivers and transmitters of standard make; you will be paid cash immediately without bother or red tape.

We also have a store at 2335 Westwood Blvd., West Los Angeles, Calif.

COMPLETE STOCKS

★ We still have large stocks of receivers, 2½ meter equipment, meters, tubes, transformers, resistors, condensers, panels, chassis, and radio parts of all sorts. We sell and rent code teaching equipment. Your orders and inquiries invited.



"WORLD'S LARGEST DISTRIBUTOR OF COMMUNICATIONS RECEIVERS"



ager, volunteered in the army two years ago and was last heard from in the North African sector.

★

G. E. SHIFTS PORTER

John G. Porter has been placed in charge of all sales promotion activities of the Transmitter and Electronic Tube Divisions of the General Electric Radio, Television and Electronics Department, Schenectady, N. Y., according to a recent announcement by H. J. Deines, Advertising Manager. He formerly was with the G-E Publicity Department.

★

GOLEPAUL AGAIN HEADS EASTERN SALES MANAGERS' CLUB

Elected at the October meeting to the chairmanship of the Sales Managers' Club, Eastern Division, this will be the third term of service rendered by Charley Golenpaul, well-known sales executive of Aerovox Corporation. It was Charley who organized this group in April, 1935. He served for two terms as chairman until 1937. Since then he has been just as active in the interests of the radio parts trade, both in and out of the club.

★

SURPLUS EQUIPMENT QUESTIONNAIRE

To supply all radio licensees and government war agencies with complete information, the Federal Communications Commission has asked that each licensee advise the Commission of the amount and condition of all surplus equipment. A questionnaire requires such description as to the size, power, frequency range emission, scale, etc.,

and a statement as to whether the item is new or used. If used the licensee is asked to classify it under (1) good serviceable condition, (2) requires minor repairs, (3) requires major repairs.

The Commission anticipates that the equipment program will permit many broadcast stations to continue operation which would otherwise be forced to remain silent for at least temporary periods. The plan will also, it is said, lessen pressure on manufacturing facilities now urgently needed for military equipment and as a by-product permit stations to dispose of equipment which is useless to them but may be utilized by others.

"Selling prices should not be quoted," the notice states. "It is understood that the listing of the information sought does not necessarily constitute an offer to sell. This is merely a means of making the information available to interested parties."

Licensees are asked to refrain from listing any equipment which cannot be repaired. Neither should transmitters which are presently licensed or which are registered under Order No. 99 be listed or normal spares to licensed equipment. All other equipment should be. When material listed is no longer available or when additional equipment becomes available, the Commission asks that it be so advised.

When the survey has been completed by the Surplus Equipment Section of the Engineering Department of the Commission, the information will be analyzed catalogued and distributed as a federal publication.

★

ALL OUT FOR VICTORY

AND HERE'S HOW TO DO IT

- By hard work, sacrifice and untiring effort.
- By fostering and actively participating in community spirit and enterprise.
- By buying war bonds and more war bonds.
- By giving our armed forces every possible form of support.

LET'S ALL PITCH IN — IT'S "OUR" FIGHT!

Erwood Sound Equipment Co.

223 WEST ERIE STREET

CHICAGO, ILL.

CARTER SOLVES YOUR *Dynamotor* PROBLEMS

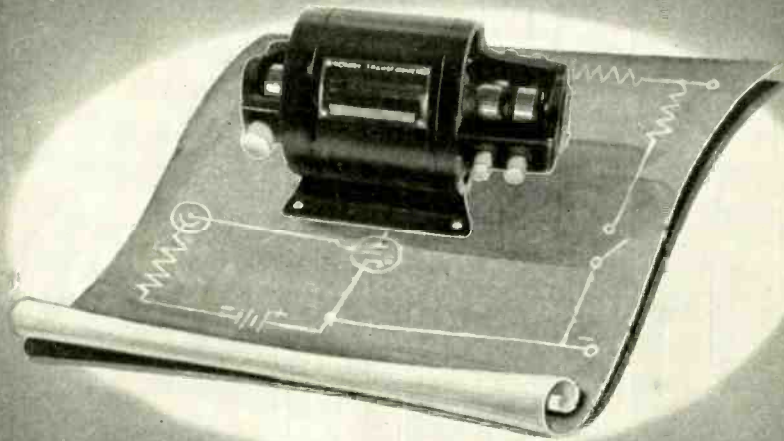

For many years, Carter Dynamotors have been a familiar part of the specifications of leading Communication Equipment Manufacturers, Police Departments, Government Agencies, etc. May we suggest you submit your Dynamotor requirements too, and see for yourself the reason for this recognized preference.

The latest catalog of Carter Dynamotors, Converters, Permanent Magnet Generators and Dynamotors, and special rotary equipment will be sent upon request.

Carter Motor Co.
Chicago, Illinois

1605 Milwaukee Ave. Carter, a well known name in radio for over twenty years. Cable: Genemotor



Talk With Your RADIO PARTS JOBBER

● An over-the-counter conversation with your Radio Parts Jobber will supply answers to most of the questions you may have concerning the availability of Astatic parts for replacement or repair of existing radio, public address or phonograph equipment. Many Astatic products you may desire are still available in jobber stocks. In any case, your Radio Parts Jobber is the man who knows. He will serve you to the best of his ability.

ASTATIC

THE ASTATIC CORPORATION

YOUNGSTOWN, OHIO

Licensed Under British
Development Co. Patents

In Canada
Canadian Astatic Ltd.
Toronto, Ontario

HALF RATE ON WIRED MONEY

Members of the United States Armed Forces and persons sending money to them will receive a 50 percent reduction in domestic telegraph money order rates, effective December 1, 1942, it was announced by the Federal Communications Commission. The Commission suggested consideration of such action by the Western Union Telegraph Company and the Postal Telegraph-Cable Co. in line with the reduction by the telegraph companies on July 23 of cabled mail order rates to the Expeditionary Forces.

There will be a flat rate of 50 cents for orders of \$10 or less, and 65 cents for orders up to \$25. The reduced rates will not apply to orders for more than \$25. Personal messages may be included with these telegraph money orders at the usual extra word rates for telegrams.

The telegraph companies are handling about one-quarter million telegraph money orders each month to and from members of the Armed Forces.

★

HUTCHINS RE-JOINS U.S.N.R.

Ever since Pearl Harbor, Henry Hutchins, General Sales Manager of National Union has felt the urge to return to the Naval Service to do his bit.

Henry up and did it, and is now Lieutenant Commander Hutchins, U.S. Naval Reserve on active duty.

We know Hutchins will do a swell job wherever he is and look forward to the day this war will be over when he will be back with National Union again.

★

VECTOR ALGEBRA

[Continued from page 16]

$$Z_T = Z_1 + \frac{Z_2 Z_3}{Z_2 + Z_3}$$

$$Z_T = 10 + j 12.6 + \frac{49.8 \angle -53^\circ \times 32.1 \angle 51.4^\circ}{30 - j 39.8 + 20 + j 25.1}$$

$$= 10 + j 12.6 + \frac{1600 \angle -1.6^\circ}{50 - j 14.7}$$

Converting,

$$50 - j 14.7 = 52.6 \angle -16.4^\circ$$

$$Z_T = 10 + j 12.6 + 32 \angle 14.8^\circ$$

Converting,

$$32 \angle 14.8^\circ = 31 + j 8.2$$

$$Z_T = 41 + j 20.8 = 46 \angle 26.9^\circ$$

$$E = IR = 46 \angle 26.9^\circ \times 2.18 \angle -26.8^\circ$$

$$E = 100 \angle 0^\circ \text{ Vector Volts}$$

The foregoing discussion and examples should indicate the fundamental

properties of vectors, and show the general methods for determining circuit parameters through their use. It should not be assumed that the only advantage offered by vectors in radio work is the solution of such simple circuits as those defined in the examples, for vector algebra is valuable wherever phase shift occurs, and is therefore applicable to most a.c. circuits. It is obviously beyond the scope of this paper to enumerate the multitudes of specific problems which are simplified by this method of calculation. For further reading and study, the following texts are recommended:

Terman, F. E.: *Radio Engineering*
 Everitt, W. L.: *Fundamentals of Radio*

Cooke, N. M.: *Mathematics for Electricians and Radiomen*

Leow, E. A.: *Direct and Alternating Currents*

Kerchner and Corcoran: *Alternating Current Circuits*

Everitt, W. L.: *Communication Engineering*

Nilson and Hornung: *Practical Radio Communication*

NEW CATALOGS

NEW SOLAR CATALOGS

Solar Manufacturing Co., Bayonne, New Jersey, have available for distribution to manufacturers and engineers, three new catalogs covering their individual capacitor lines.

Catalog 12—Section A, of 32 pages, covers the mechanical and electrical specifications of Solar wet and dry electrolytic capacitors.

Catalog 12—Section C, of 48 pages, provides similar specifications on all types of paper capacitors, including oil-impregnated types.

Catalog 12—Section E, of 32 pages, deals with receiving, transmitting, and special type mica capacitors.

★

SHALLCROSS BULLETINS

Three bulletins of particular interest to manufacturers and engineers allied with war production, have been issued by Shallcross.

"Electrical Resistance Measurements" covers the Shallcross No. 630 Wheatstone Bridge, the No. 638-1 Kelvin Wheatstone Bridge, and the No. 621-A Per%Cent Limit Bridge. Complete specifications are given.

"Current Flow Test Sets" provides similar data on the Shallcross No. 696 and No. 695 Current Flow Test Sets, designed for the testing and adjustment of various types of relays.

The third bulletin covers Shallcross

Built-in Precision

... Accuracy and dependability are built into every Bliley Crystal Unit. Specify **BLILEY** for assured performance.

BLILEY ELECTRIC COMPANY

UNION STATION BUILDING ERIE, PA.

IN THE THICK OF THE ACTION

Where the battle is hottest, there you will find radio communications leading the way to Victory. And there you'll find the reason why BUD Products are in such great demand by America's armed forces.

BUD RADIO, INC. Cleveland, Ohio

Electric Bond Testers, for measuring the electrical resistance of all types of metal bonds and joints.

Those requesting copies of these bulletins should write to the Shallcross Mfg. Co., Dept. 28, Collingdale, Penna.

★

CARTER MOTOR CATALOG

Carter Motor Company, 1605 Milwaukee Ave., Chicago, Ill., have available for distribution their new Catalog No. 100, covering the complete line of Carter Dynamotors and Generators.

Of particular interest is the new "Magmotor," a permanent-magnet dynamotor, the 100-watt models of which weigh only 4¾ pounds. A "Magmotor" Hand Generator is also described.

★

AEROPOINT INSTRUMENT PIVOT MANUAL

The Paroloy Company, 600 South Michigan Ave., Chicago, announces the publication of a complete pivot manual covering specific and technical information on the application of long life "Permium" alloy pivots as used in all types of instruments.

This bulletin is prepared to acquaint manufacturers and engineers with the new long life "Aeropoint" instrument pivots, which are designed to resist

wear and vibration abuse, thereby forestalling instrument servicing and maintenance upkeep.

These bulletins are sent to all instrument men, manufacturers, engineers, and users of instruments free upon request on their letterheads.

★

FOLDER ON GRINDING-ROOM PRODUCTS

The George Scherr Company has just brought out a new eight page folder describing its line of time-saving devices for the grinding room. Included is a complete description of Magne-Blox products, Magnetic Parallels used on magnetic chucks for holding work for surface grinding operations, and Radius Dresser for dressing radii from 0 to 1". Other products in the George Scherr Company line are briefly described.

BRIDGE BALANCING

[Continued from page 11]

$$\frac{R_1}{R_2} = \frac{Z_2 - Z_1}{Z_1 - Z_2} = \frac{Z_2 - \sqrt{Z_1 Z_2}}{Z_1 - \sqrt{Z_1 Z_2}} = \frac{\sqrt{Z_2}(\sqrt{Z_2} - \sqrt{Z_1})}{\sqrt{Z_1}(\sqrt{Z_1} - \sqrt{Z_2})} = -\sqrt{\frac{Z_2}{Z_1}}$$

The resistance arms R_4 and R_3 are in positive real ratio. Hence they cannot balance the negative ratio of the equivalent inductances.

ANDERSON BRIDGE: This bridge is based on the Maxwell balance and is a commonly used arrangement for general inductance measurements. The circuit of the bridge is shown in Fig. 12-A and its equivalent network in Fig. 12-B. At balance:

$$R_1(1/R_2 + j\omega C_3) = (R_3 + j\omega L_x)1/R_4$$

or:

$$\frac{R_1}{R_2} = \frac{R_3}{R_4}$$

and:

$$R_1 R_4 = \frac{L_x}{C_3}$$

whence:

$$R_3 = \frac{R_1 R_4}{R_2}$$

and:

$$L_x = R_1 C_3 R_4$$

$$R_3 = A + B + \frac{AB}{D} = \frac{AD + BD + AB}{D}$$

and:

$$R_4 = B + D + \frac{BD}{A} = \frac{AD + BD + AB}{A}$$

Whence:

$$R_3 = R_1 \frac{R_4}{R_2} = R_1 \frac{A}{D}$$

and:

$$L_x = R_1 C_3 \left[B + D + \frac{BD}{A} \right] = R_1 C_3 \left[B \left(1 + \frac{D}{A} \right) + D \right]$$

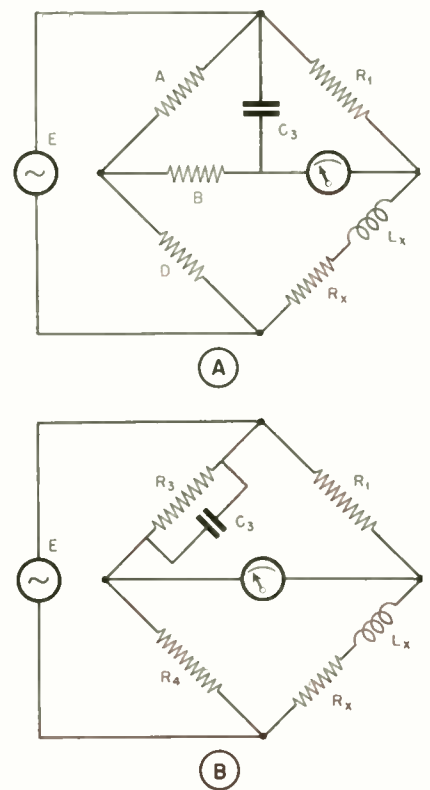

Fig. 12. Anderson bridge and its equivalent.

Obviously the balance is independent of frequency. Capacity C_3 may be fixed and the bridge may be balanced by varying resistors R_1 and B . We could, of course, obtain a balance by using C_3 and B as variables.

NEW PRODUCTS

[Continued from page 22]

BOB in bakelite); withstands vibratory motion to 12G with $2\frac{1}{2}$ -watt operating power; operates at temperatures of $+70^\circ\text{C}$. or -50°C .; resists corrosion beyond any present specifications; dimensions, (screw or shake-proof nut) $1\frac{5}{8} \times 1\frac{17}{32} \times 1\frac{1}{8}$ inches—(bakelite mounting, model BOB) $2\frac{5}{8} \times 1\frac{7}{8} \times 2\frac{3}{16}$ inches.

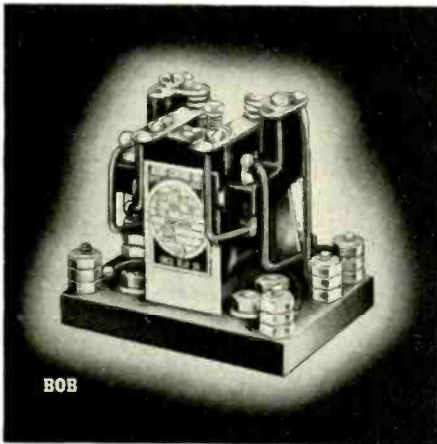

BOB

The specifications for BJ are: contact ratings, non-inductive, 5 amperes for 12 and 24 volts d.c. and 110 volts a.c.; single or double pole, double throw; weights, $2\frac{1}{4}$ ounces with screw stud mounting or $5\frac{1}{4}$ ounces with bakelite mounting (model BJB in bakelite); withstand vibratory motion to 12G with 2 watts operating power; operates at temperatures of $+70^\circ\text{C}$. or -50°C . and resists corrosion beyond any present specifications; dimensions, (screw stud mounting) $2\frac{5}{16} \times 1\frac{11}{16} \times 1\frac{9}{16}$ inches (bakelite mounting, model BJB) $2\frac{7}{16} \times 1\frac{11}{16} \times 1\frac{15}{16}$.

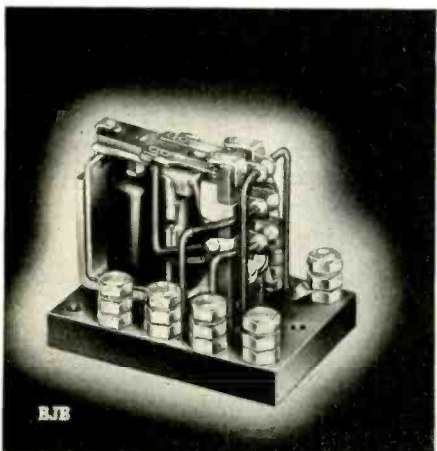

BJB

RADIO, ELECTRONIC AND SOUND SUPPLIES AVAILABLE!

Lafayette is your COMPLETE source of supply, especially on those hard to find Electronic, Radio and Sound Equipment parts . . . no order too small or too large for our prompt attention. LAFAYETTE GIVES YOU IMMEDIATE ACTION on deliveries! Lafayette personnel is trained to work with your expeditors.

If quick delivery of engineering samples, or production quantities is your problem, write, wire or phone Lafayette.

FREE Buyers Guide!—130 pages indexed for quick reference . . . Get your copy now! Address Dept. 12F2, 901 W. Jackson Boulevard, Chicago, Ill.

[Camera Fans—Photographic equipment at lowest prices! Write for complete catalog.]

LAFAYETTE RADIO CORP.

901 W. JACKSON BLVD., CHICAGO, ILL. • 265 PEACHTREE ST., ATLANTA, GA.



Transmitting tubes, panel lamps, dry batteries, volume controls, cathode ray tubes, exciter lamps, sound equipment, photo electric cells, condensers, flash light bulbs, Radio tubes.

TRANSMITTING AND SPECIAL PURPOSE TUBES

including

THE LATEST TYPE OF HIGH FREQUENCY TUBES
such as:

832 • 829 • 615 • 114B • 813 • 1201 • 1203A

A COMPLETE LINE OF TRANSMITTING TUBES IN ALL IMPORTANT SIZES UP TO 200 WATTS

for your **ELECTRONIC tubes • parts • supplies**

SEE YOUR LOCAL NATIONAL UNION DISTRIBUTOR

EVERY research department today is working with electronic principles. NATIONAL UNION DISTRIBUTORS handle National Union Radio tubes and allied products. They specialize in radio and electronic items and you will find their stocks very complete. Call or write your N.U. distributor for his industrial catalogue. If you do not know his address send your letter to us and we will forward it.



NATIONAL UNION RADIO CORP.

57 STATE STREET, NEWARK, NEW JERSEY

We are
Pitching
for
Uncle Sam
for the
Duration!!

Our Army
of workers
and engineers
will be intact
—to serve our
many good
customers—

*when it's over
over there!*!

HENRY FORSTER
President

RADIO SPEAKERS

INCORPORATED

221 East Cullerton St.
Chicago, Illinois

NEW PAPER TUBE SIZES

Paramount new arbors and specially designed automatic machines make it possible to produce spirally-wrapped paper tubing or cores of greater strength and closer tolerance, in a wider range of sizes, for coil forms and other uses.

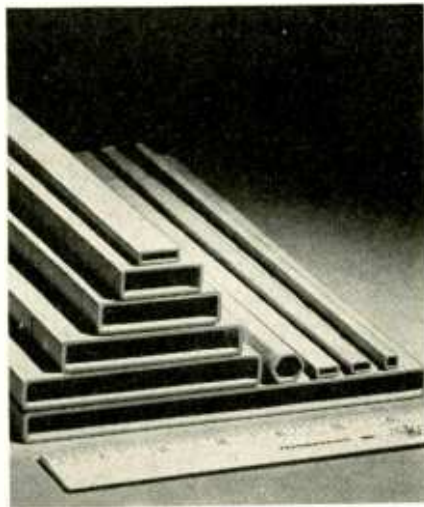

These paper tubes can be supplied in high dielectric Kraft, Fish Paper, Red Rope, Acetate or combination wound—in square, round, or rectangular shapes—in continuous lengths—in any wall thickness—with any ID or OD (as small as 3/16" square inside or as large as 4" square inside). The tubes have square corners and straight side walls. By Paramount Paper Tube Co., 800 Glasgow Ave., Fort Wayne, Ind.

★

NEW PILOT-LIGHT ASSEMBLY

The new Gothard No. 800 series Pilot-Light Assembly is designed for installations where it is desirable to insert a new lamp bulb, at the rear of a switchboard panel, without disturbing the electrical wiring. The new assembly fulfills this requirement, as the lower half snaps apart from the body. Locking pins in the spring member make a secure assembly, free from rattle. The one-inch jewel is held in a separate ring which slips in the tube. This also permits insertion of a new bulb from the front of the panel. All parts heavily plated and jewel bezel polished.

★

HARWOOD CABLE CONNECTOR

A new electrical cable connector that eliminates one coupling nut and one barrel, providing a three-piece, split-shell construction, is now in production at The Harwood Co., 747 N. Highland Ave., Los Angeles, California.

Assembly and maintenance are speeded by this lighter, more simplified con-



● This popular round-can oil-filled transmitting capacitor has donned fighting clothes "for the duration". Gone is the shiny aluminum can, for aluminum is a premium war metal that must be conserved. In its place is the fighting touch of gray paint protecting the ribbed and reinforced steel can.

It's a still tougher capacitor, this wartime Type —05. The high-voltage ceramic insulators slip over screw-stud assemblies including double rubber bakelite washers and lock nuts for a perfect electrical and mechanical construction. The three-point support of the adjustable mounting ring means rigid upright or inverted mounting with terminals at top or bottom, any height above or below chassis. In its fighting togs, this Type —05 is a tougher capacitor for the toughest wartime demands.

● Ask Our Jobber . . .

Ask for a copy of the new "Victory" catalog. Ask for free subscription to monthly Aerovox Research Worker. Or write us direct.



VOKAR

**CURRENTLY
PRODUCING**

**JK26 JK48 JACKS
FT243 CRYSTAL HOLDERS**



**Radio and Electrical
Assemblies**



**WRITE FOR
INFORMATION**



**ELECTRONIC PRODUCTS
MFG. CORP.**

**7300 Huron River Drive
DEXTER, MICHIGAN**

LEARN CODE!



ONLY
\$9.85

COMPLETE

**Official U. S. Signal Corps
Field Telephone - Telegraph
Outfit**

JUST RELEASED FOR CIVILIAN USE!

- CONSTANT FREQUENCY BUZZER
- ADJUSTABLE KEY
- WORKS AS TELEPHONE OR TELEGRAPH OVER HUNDREDS OF FEET ON A LINE WITHOUT EXTERNAL BATTERIES
- SELF CONTAINED BATTERY PORTABLE
- GENUINE COWHIDE LEATHER CARRYING CASE
- WEIGHS ONLY 5½ LBS. COMPLETE

—MAIL ORDERS FILLED—

Please accompany all mail orders by postal money order, including 75c to cover cost of special handling, packing, insurance and postage. Address Box R-12.

QUANTITY LIMITED—SO HURRY!

New York's Oldest Radio Supply House

SUN RADIO CO.
212 FULTON ST.
NEW YORK, N. Y.

struction, according to the manufacturer. Greater speed of installation gives consequent savings in time and cost of installation.

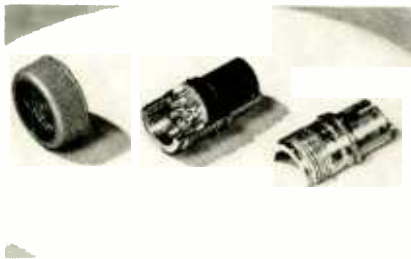

Entirely of die cast construction, this new simplified connector conforms in all respects to Army-Navy specifications. A complete range of Harwood connectors from sizes 10S to 48 is offered in the three-piece construction.



NEW PLASTIC

Plastic compositions which can replace steel or other metals in many uses may now be manufactured by incorporating with various cellulosic fibers a resin powder known as Vinsol, extracted by Hercules Powder Company chemists from the Southern pine tree. The Patent and Licensing Corporation, New York, has announced.

This new structural resin plastic is an addition to the growing family of resin-treated laminated paper products. It is a thermoplastic, fibrous-resin composition, hard, dense, stiff but with reasonable toughness. It is described as sturdy but lightweight, and has low water absorption.



NEW STACKPOLE IRON CORES

New materials recently developed by the Stackpole Carbon Company of St. Marys, Pa. have resulted in the introduction of molded iron cores which

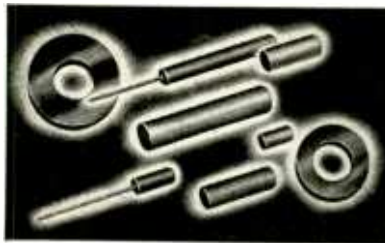

show outstandingly favorable characteristics at frequencies as high as 150 to 175 megacycles. Combining a permeability of approximately 5 with high Q, the new Stackpole iron cores represent a big forward step in matching the needs of much of the present-day high-frequency equipment.

Like other Stackpole cores available in practically every type for frequen-

COVINGTON LAPIDARY EQUIPMENT FOR QUARTZ CRYSTAL PRODUCTION

Used by the U. S. Government



Send for Literature to
Covington Lapidary
Engineering Co.
Redlands, Cal.



BONDS BUY BOMBS

NOW — A REALLY HIGH-POWERED —

Radio Engineering Library

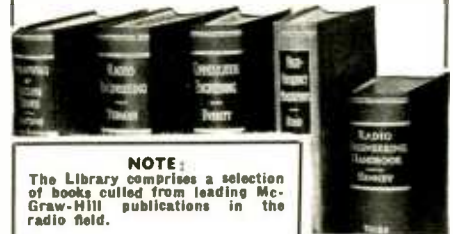

NOTE:
The Library comprises a selection of books culled from leading McGraw-Hill publications in the radio field.

- especially selected by radio specialists of McGraw-Hill publications
- to give most complete, dependable coverage of facts needed by all whose fields are grounded on radio fundamentals
- available at a special price and terms

THESE books cover circuit phenomena, tube theory, networks, measurements, and other subjects—give specialized treatments of all fields of practical design and application. They are books of recognized position in the literature—books you will refer to and be referred to often. If you are a practical designer, researcher or engineer in any field based on radio, you want these books for the help they give in hundreds of problems throughout the whole field of radio engineering.

5 Volumes, 3319 Pages, 2289 Illustrations

1. Eastman's FUNDAMENTALS OF VACUUM TUBES
2. Terman's RADIO ENGINEERING
3. Everitt's COMMUNICATION ENGINEERING
4. Hund's HIGH FREQUENCY MEASUREMENTS
5. Henney's RADIO ENGINEERING HANDBOOK

10 days' examination. Easy terms. Special price under this offer less than books bought separately. Add these standard works to your library now; pay small monthly installments, while you use the books.

10 DAYS' FREE EXAMINATION—SEND COUPON

.....
McGraw-Hill Book Co., 330 W. 42nd St., NYC

Send me Radio Engineering Library, 5 vols., for 10 days' examination on approval. In 10 days I will send \$3.00 plus few cents postage, and \$3.00 monthly till \$24.00 is paid, or return books postpaid. (We pay postage on orders accompanied by remittance of first installment.)

Name
Address
City and State
Position
Company R. 12-42
.....

QUANTITY DELIVERY NOW

For Government contracting and subcontracting for land, sea and other field communications devices.

Types PL-54, PL-55, PL-68, JK-26, JK-48 and companion plug, and SW-141.

Universal Microphone Co., Ltd.
Inglewood Calif.

BIG FREE CATALOG

EVERYTHING IN RADIO

Sets, parts, supplies, public address systems, amateur equipment, testers, kits and fluorescent lighting at lowest prices. Huge stocks, bought months ago ready for shipment the same day your order is received. The Defense Program is making big demands on our industry but because of our advance buying we are able to fill your orders promptly and efficiently.

BURSTEIN-APPLEBEE COMPANY
1012-14 McGEE, KANSAS CITY, MO.

RADIO
CATALOG NO. 58
164 PAGES
SETS-PARTS
SUPPLIES
FLUORESCENT

ADVERTISING INDEX

Aerovox Corp.	48
Allied Control Co., Inc.	36
Astatic Corp.	44
Bliley Electric Co.	45
Bud Radio, Inc.	45
Burstein-Applebee Co.	50
Carter Motor Co.	44
Centralab	37
Covington Lapidary Eng. Co.	49
Echophone Radio Co.	23
Editors and Engineers	38
Eitel-McCullough, Inc.	33
Electronic Laboratories, Inc.	Cover 4
Electronic Products Mfg. Corp.	49
Erwood Sound Equipment Co.	43
Guardian Electric Co.	27
Hallicrafters Co., The	3, 4
Henry Radio Shop	42
International Resistance Co.	8
Jensen Radio Mfg. Co.	6
Johnson Co., E. F.	39
Lafayette Radio Corp.	47
Lenz Electric Mfg. Co.	25
Mallory & Co., P. R.	40
McGraw-Hill Book Co., Inc.	49
Meissner Mfg. Co.	31
Muter Co., The	43
National Co., Inc.	Cover 3
National Union Radio Corp.	47
Pioneer Gen-E-Motor	46
Racon Electric Co.	35
Radio Speakers, Inc.	48
Solar Mfg. Co.	49
Sun Radio Co.	49
Thermador Electrical Mfg. Co.	28
United Transformer Co.	Cover 2
Universal Microphone Co., Ltd.	50

cies up to 50 megacycles, these newer units are outstanding for their uniformity. All engineering samples are made on the same equipment that is used in actual quantity production.

Engineering details on any type will gladly be sent upon request.

★

NEW WELDING TRANSFORMERS

Speeding production of war material has created manufacturing problems oftentimes never experienced in the production of peacetime goods. As a result much production machinery has been designed to perform a specific operation or function. As an example, The Acme Electric & Manufacturing Co., Cuba, New York, announce the development of special welding transformers for operation on primary circuits of 115-volt, single-phase, 60-cycle and having secondary characteristics of 0.75 volt, 1600 amperes.

★

DECADES AND BRIDGES

Because of the heavy and urgent demand for standard laboratory equipment of the Wheatstone Bridge and Decade Resistance Box categories, Industrial Instruments, Inc., 156 Culver Ave., Jersey City, N. J., now announces its line of such instruments.

Type DR D.C. Resistance Decades are available in standard models with resistance ranges of .9 to 999,999 ohms total and with guaranteed accuracy of plus/minus 1% and 1.0% respectively, in two price classes. All coils are of manganin wire excepting the 100,000 ohm coils of Nichrome. All coils are bifilar-wound on ceramic tubes, oven-baked and protectively-coated. Switches have self-cleaning multi-blade phosphor-bronze spring wipers. The instru-



ments are housed in rubbed walnut cases.

Wheatstone Bridge Type RN-1 contains four resistance dials with nine positions each, covering 9 X 1, 9 X 10, 9 X 100, and 9 X 1000 ohms, with decade multiplying dials. The ratio resistances have a guaranteed accuracy of plus/minus .05%, while the resistance coils in the decades of the bridge are guaranteed to plus/minus .1% tolerance.

ADDRESS CHANGE?

Notify RADIO's Circulation Department at 132 West 43rd Street, New York, N. Y., of your new address two or three weeks before you move. The Post Office Department does not forward magazines sent to a wrong address unless you pay additional postage. We cannot duplicate copies mailed to your old address. Thank you!

HALF PRICE SUBSCRIPTIONS . . .

for Men in the U. S. Armed Services

Subscriptions to "RADIO" addressed to men in the U. S. Army, Navy, Marine Corps, or Coast Guard will be accepted at the below-cost rate of \$1.50 per year. Subscriptions at this rate (whether ordered by the addressee or a donor) should be accompanied by a remittance in full; addressee's rank and military address must be given. This rate applies wherever domestic U. S. postal service extends, including naval units at sea and overseas army postoffices. No cancellations or refunds.

Simply write rank, name, and military address on a slip of paper and send, accompanied by remittance, to

Radio Magazines, Inc., 132 W. 43rd St., New York, N. Y.



EASY DOES IT!

A difficult job being well done — easy does it! Modern warfare on seven oceans puts a premium on efficient, unfailing communications. National equipment is covering all seven of them.

NATIONAL COMPANY, INC.
MALDEN, MASS.

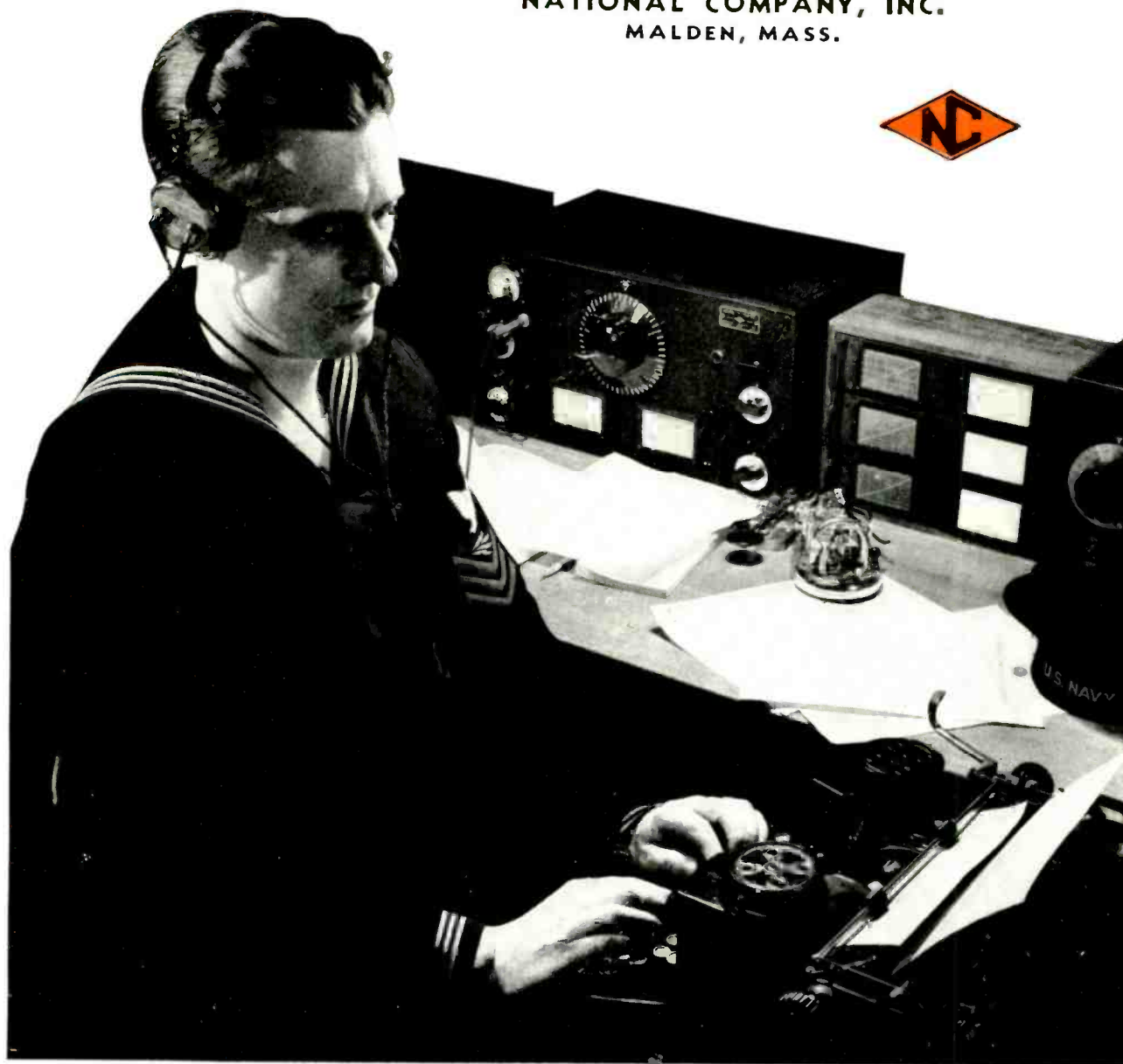

WE'RE KEEPING **Tough** COMPANY

... and we're **PROUD** of it!



H. M. S. ILLUSTRIOUS
SELECTS ELECTRONIC

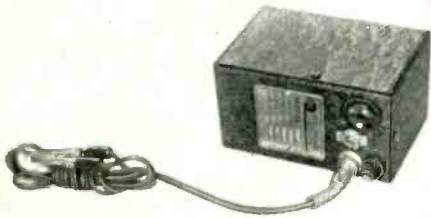

Designed for Operating Portable Test Equipment in the Field

Input Voltage: 12 Volts
Output: 110 AC, 180 Cycles
Wattage Capacity: 30 Watts
Size: 4" x 4" x 6"
Weight: 3 lbs.
Efficiency: 75%

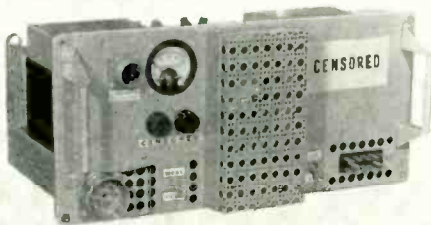

Tough Problem—But Electronic Licked It!

Input: 12 Volts DC or 110 Volts AC.
Output: 2000 Volts DC at 200 Ma.
450 Volts DC at 70 Ma.
+250 Volts at 30 Ma.
-250 Volts at 25 Ma.
10 Volts AC 7 Amperes
Approximate output wattage, 500 watts
Weight: 56 lbs. Size: 19" x 11" x 8"
Efficiency: 65%
Regulation: 13%
Designed for continuous operation at full load

IN RETURNING TO ACTION, after recent refitting, *H.M.S. Illustrious* relies on newly installed ELECTRONIC equipment . . . not only for herself but for the planes that fly from her decks. Tough company? Yes! *Magnificently so!* But only *one* of many rugged military assignments for Electronic: Tanks! Walkie-Talkies! Mobile Amplifiers! Jeeps! P-T Boats! *Not a "softie" in the lot!*

BECAUSE IT TAKES TOUGH PRODUCTS to keep tough company, Electronic is justly proud of her wartime role. And *tomorrow* Electronic Power Supplies will return to peacetime pursuits . . . at *your* service . . . *tougher* and *better* in every way because of their combat experience. Until then . . . **CARRY ON!**

Electronic

LABORATORIES, INC.



INDIANAPOLIS